



SCTE&VT

State Council for Technical Education &
Vocational Training

Government of Odisha



LECTURE NOTES
ON
Structural Design-II (Th.2)
Diploma 5th Semester

विद्या ददाति विनयम्

DEPARTMENT OF CIVIL ENGINEERING
Govt. Polytechnic, Nayagarh

Lecture Notes

On

STRUCTURAL DESIGN-II

(5^h SEMESTER)

Subject Code:- Th.2

Prepared By

Er. Amlan Nayak

Sr. Lecturer Civil.

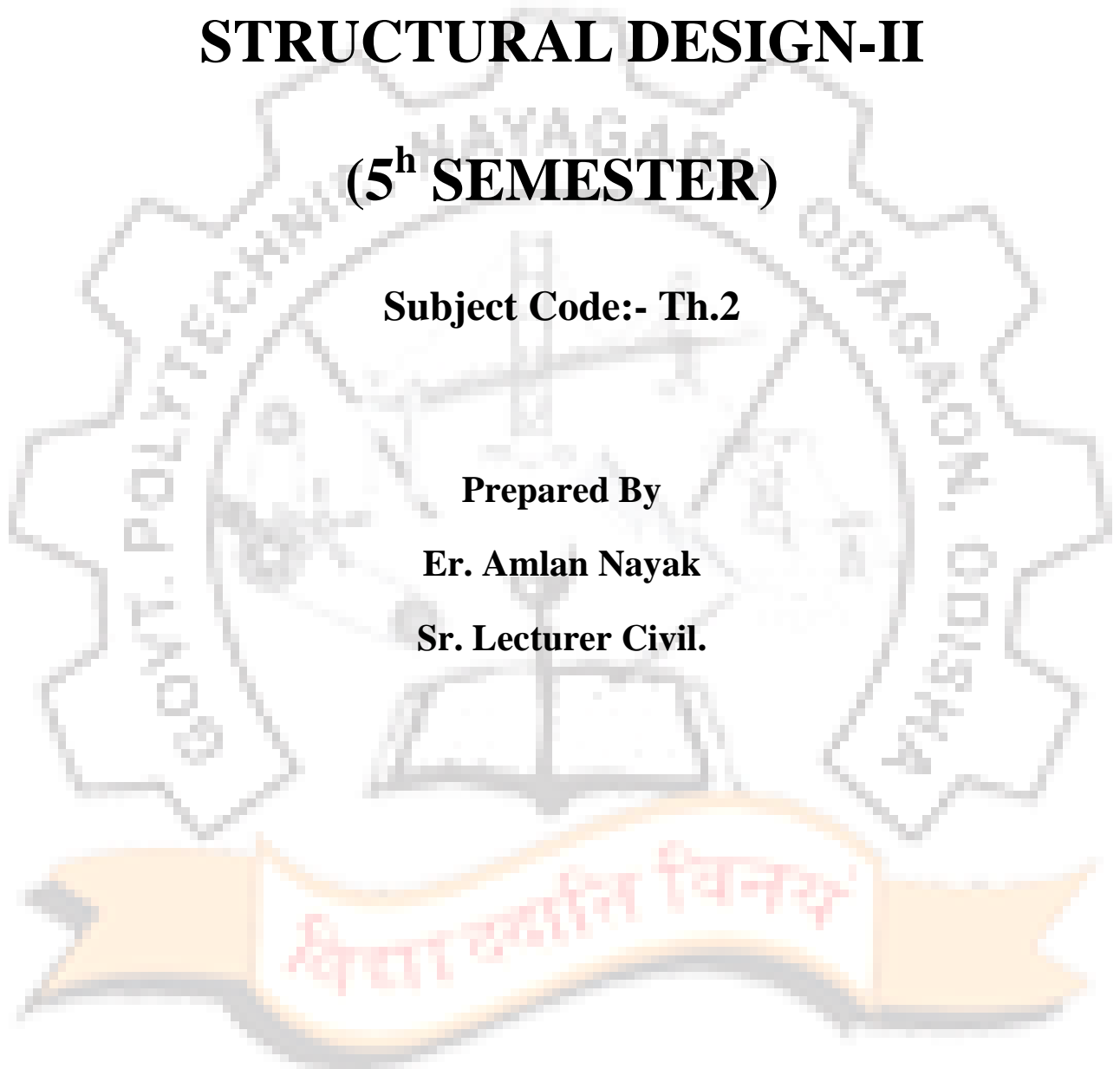

Stress-strain Behaviour of Steel

The primary characteristics of structural steel include mechanical and chemical properties, metallurgical structures and weldability. In the past structural engineers have tended to focus only on the tensile properties (longitudinal yield stress and ultimate tensile strength), with some attention paid to the deformability as measured by the elongation at fracture of a tension specimen. Since the modulus of elasticity, E , is constant for all practical purposes for all grades of steel, it has rarely been a consideration other than for serviceability issues. Weldability was assumed to be adequate for all such steels. Deformability or ductility was similarly assumed to be satisfactory, in part because the design specification has offered only very limited, specific requirements.

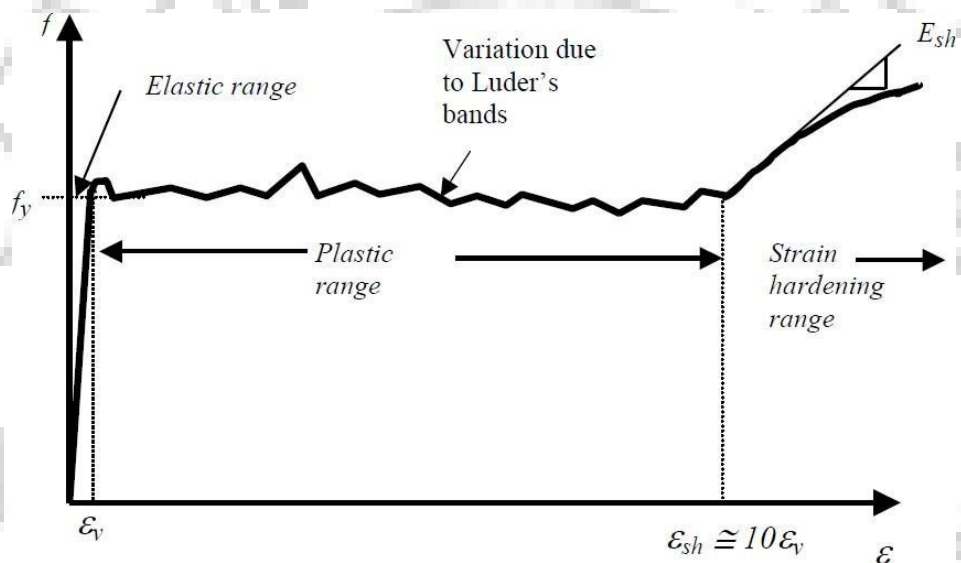

Figure 1.1 Stress-strain curve for sharp yielding structural steels

विद्या ऽऽमृतमिव विनश्यति

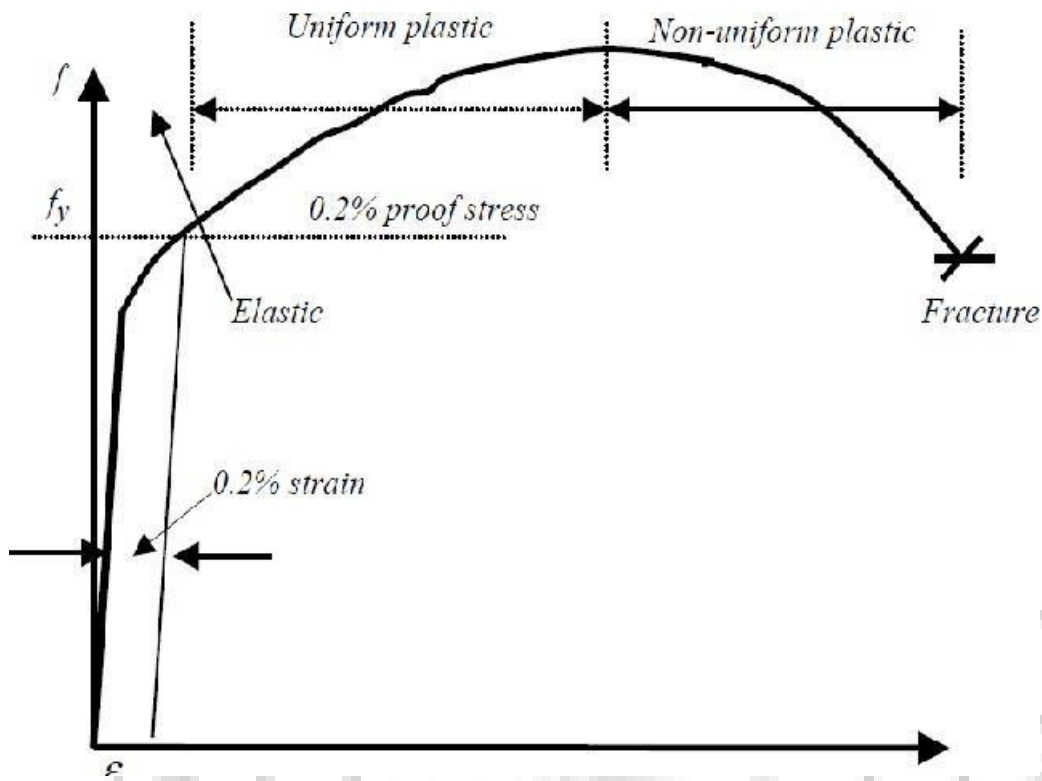

Figure 1.2 Stress strain curve for continuously yielding structural steels

Structural Steel from IS 800-2007

The provisions in this section are applicable to the steels commonly used in steel construction, namely, structural mild steel and high tensile structural steel.

All the structural steel used in general construction, coming under the purview of this standard shall before fabrication conform to IS 2062.

Structural steel other than those specified in 1.4.2 may also be used provided that the permissible stresses and other design provisions are suitably modified and the steel is also suitable for the type of fabrication adopted.

Steel that is not supported by mill test result may be used only in unimportant members and details, where their properties such as ductility and weldability would not affect the performance requirements of the members and the structure as a whole. However, such steels may be used in structural system after confirming their quality by carrying out appropriate tests in accordance with the method specified in IS 1608.

Properties:

The properties of structural steel for use in design, may be taken as given in 1.4.4.1 and 1.4.4.2.

Physical properties of structural steel irrespective of its grade may be taken as: Unit mass of steel, $p = 7850 \text{ kg/m}^3$

Modulus of elasticity, $E = 2.0 \times 10^5 \text{ N/mm}^2 \text{ (MPa)}$

Poisson ratio, $\nu = 0.3$

Modulus of rigidity, $G = 0.769 \times 10^5 \text{ N/mm}^2 \text{ (MPa)}$

Co-efficient of thermal expansion $\alpha = 12 \times 10^{-6} / ^\circ\text{C}$

Mechanical properties of structural steel

The principal mechanical properties of the structural steel important in design are the yield stress, f_y ; the tensile or ultimate stress, f_u ; the maximum percent elongation on a standard gauge length and notch toughness. Except for notch toughness, the other properties are determined by conducting tensile tests on samples cut from the plates, sections, etc, in accordance with IS 1608. Commonly used properties for the common steel products of different specifications are summarized in Table 1.4

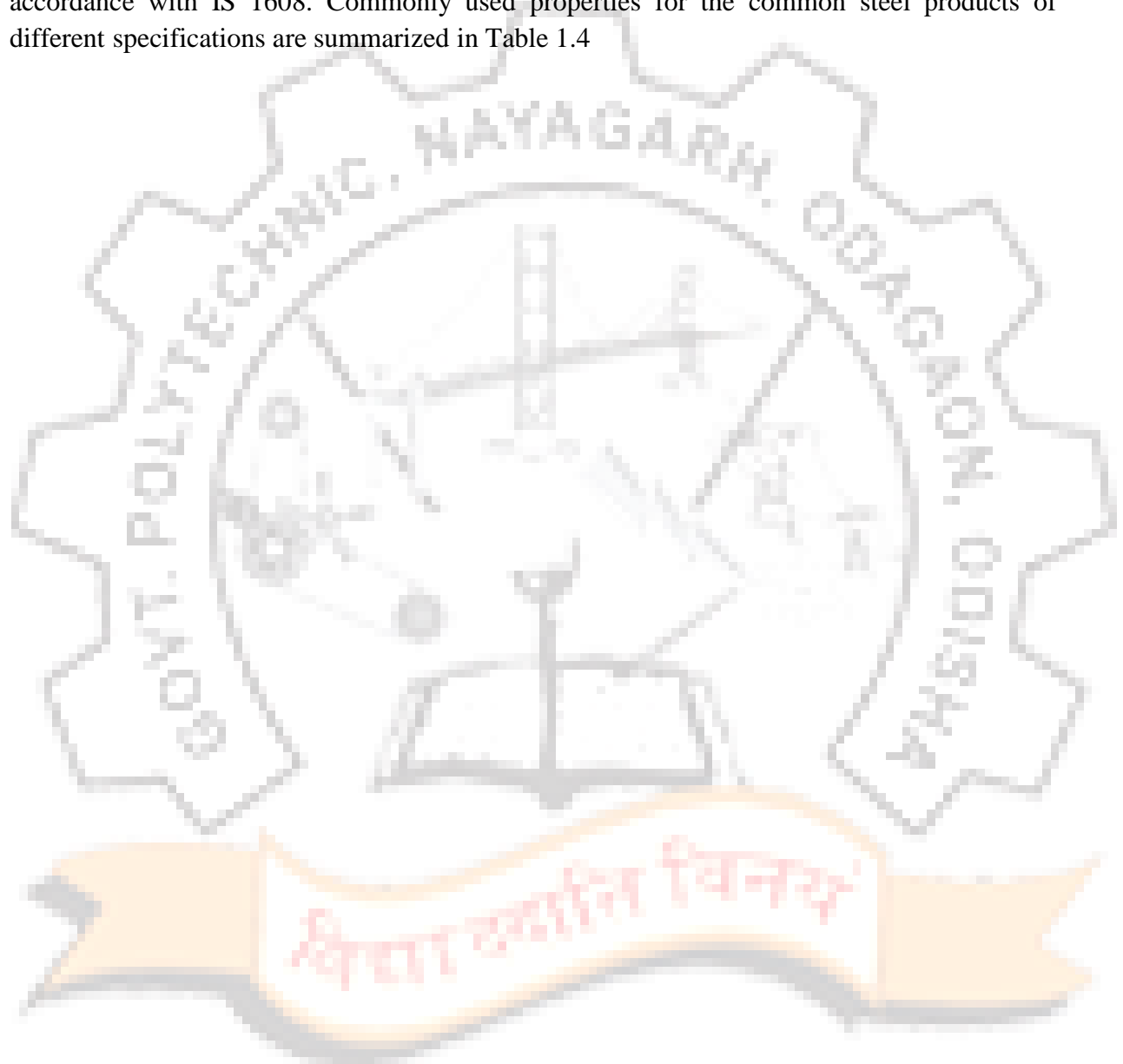

Table 1.4 Tensile Properties of Structural Steel Products

Sl No.	Indian Standard	Grade/Classification	Properties				
			Yield Stress MPa, <i>Min</i>	Ultimate Tensile Stress MPa, <i>Min</i>	Elongation, Percent, <i>Min</i>		
(1)	(2)	(3)	(4)			(5)	(6)
			<i>d or t</i>				
			< 20	20-40	> 40		
viii)	IS 2062	E 165 (Fe 290)	165	165	165	290	23
		E 250 (Fe 410 W) A	250	240	230	410	23
		E 250 (Fe 410 W) B	250	240	230	410	23
		E 250 (Fe 410 W) C	250	240	230	410	23
		E 300 (Fe 440)	300	290	280	440	22
		E 350 (Fe 490)	350	330	320	490	22
		E 410 (Fe 540)	410	390	380	540	20
		E 450 (Fe 570) D	450	430	420	570	20
		E 450 (Fe 590) E	450	430	420	590	20



Lecture 2: Concept of design of steel structures

Concept of Design of steel structures

Design problems are seldom amenable to solution by exact mathematical formulae. There is a considerable scope for exercising engineering judgement. Hence, there is no “correct solution” to a design problem, as there could be several so-called “correct solutions” to the same problem. This is because

- the designs are invariably subject to individual interpretation of Standards and Codes,
- the solutions are also subject to differing ideas about what is or what is NOT required from an engineering and environmental stand point, and
- the individual designers have ingrained ideas from their past experience, which may be valid to-day only to a limited extent, or may not be valid at all.

Thus the design problems are referred to as "open ended" problems. Nevertheless the Designer has the responsibility for ensuring that the goal of the project is achieved (i) safely, without taking any undue risks to lives and materials and without causing a liability, (ii) within time and (iii) within the (budgeted) cost. Hence, “Engineering Design” may be defined as a creative activity of building a new artefact which provides an optimum solution to satisfy a defined requirement or need, without endangering the environment.

Objectives

Having set down the goals, the designer defines the system objectives. These objectives are similar to goals but explain in detail the requirements that the system must satisfy to attain the goals. Some of the essential objectives of any project relate to health, safety and welfare requirements of the occupants, which are generally defined in local building codes or building regulations. Other special objectives include minimisation of initial costs, life-cycle costs, construction time etc. At least one criterion (e.g. Fire resistance) must be associated with each objective. A criterion is a range of values within which the performance of the system must lie (e.g. Two hours fire rating is needed). The criterion serves as a guide in the evaluation of alternative systems to the project.

विद्या ऽऽमृतमिव विनश्यत्

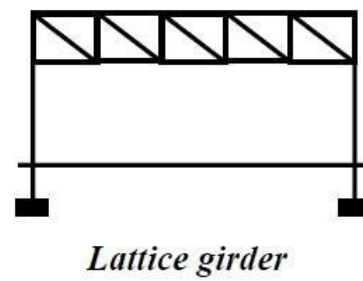
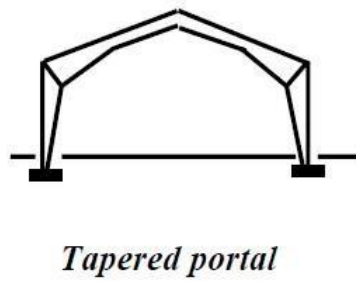
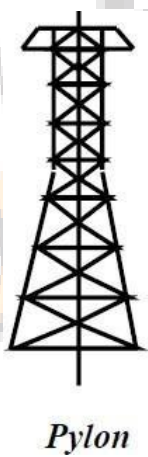
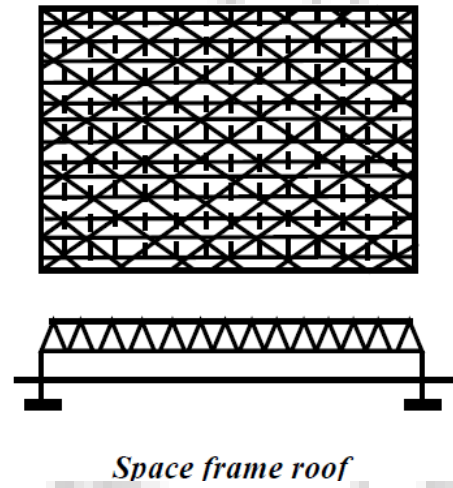
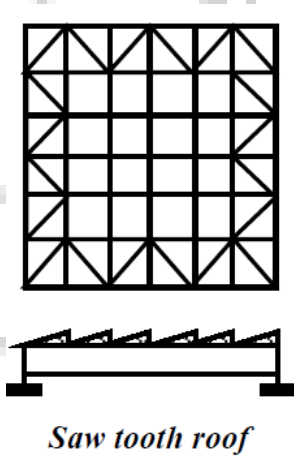
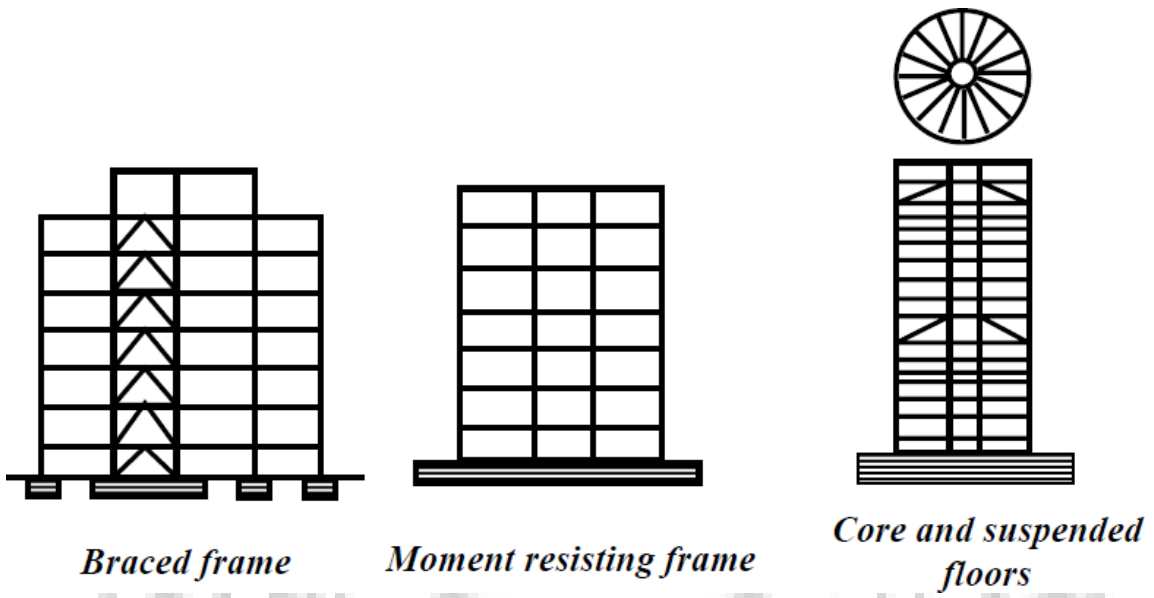

Figure 2.1 Examples of steel frame structure

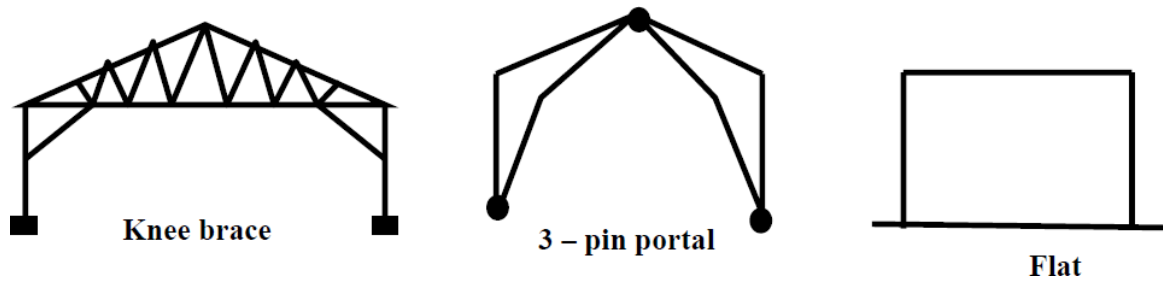

Figure 2.5 Single Bay, Single-storey Structures

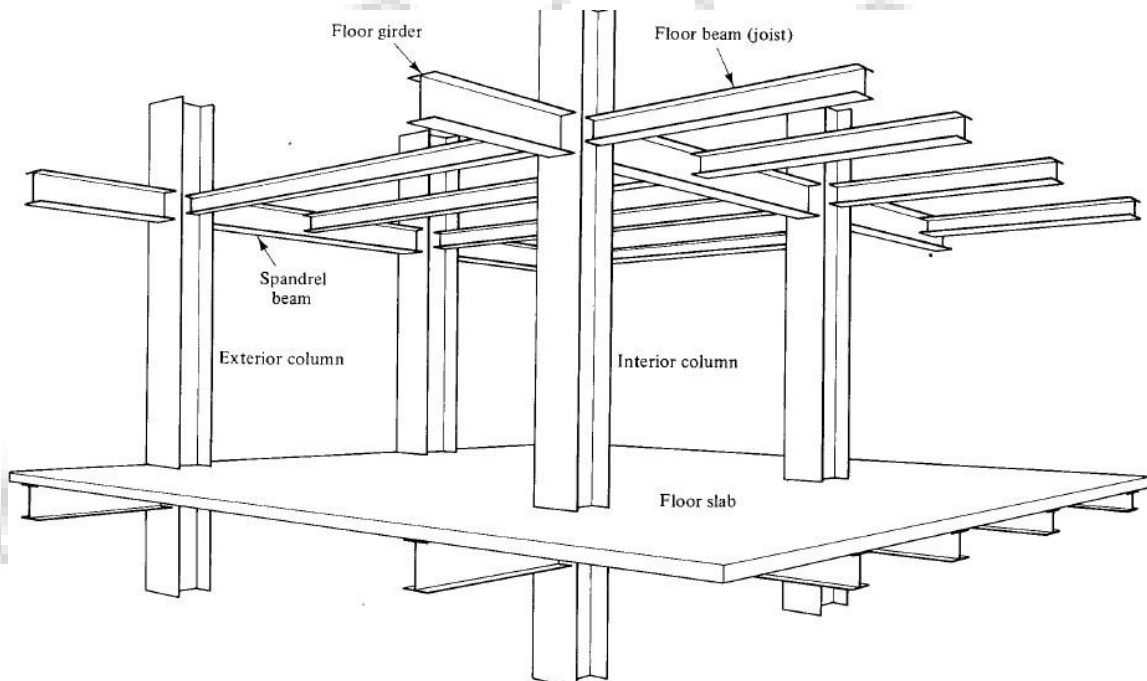
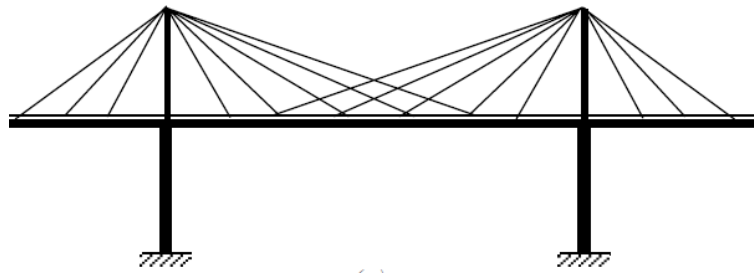
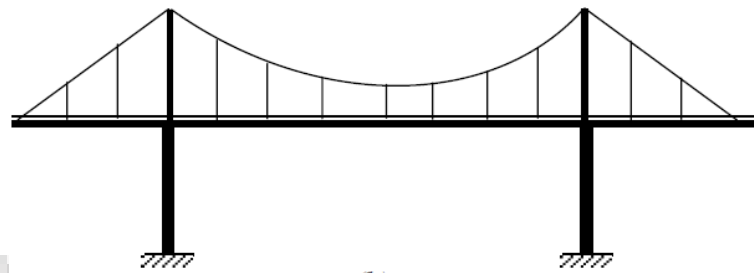

Figure 2.6 Beam and column construction

Aesthetic considerations are important in many cases and the choice of design may not always be based on cost alone. The weight saving may be offset by the higher cost of the stronger material or the higher cost of fabrication/construction of complicated systems. Often no one solution for a given structure is prominent or obvious to the exclusion of all other alternatives. As an example, we can illustrate several choices available to the designer for a single bay, single storey structure as shown in Figure 2.5. An example of beam and column system frequently used is illustrated in Figure 2.6. Cable stayed structures are frequently employed in long span bridges and buildings and are shown in Fig. 2.7. In the following chapters, the analysis and design of steel elements are discussed in depth, followed by the analysis and design of selection of structural elements.



(a)



(b)

Figure 2.7 Cable-stayed structures

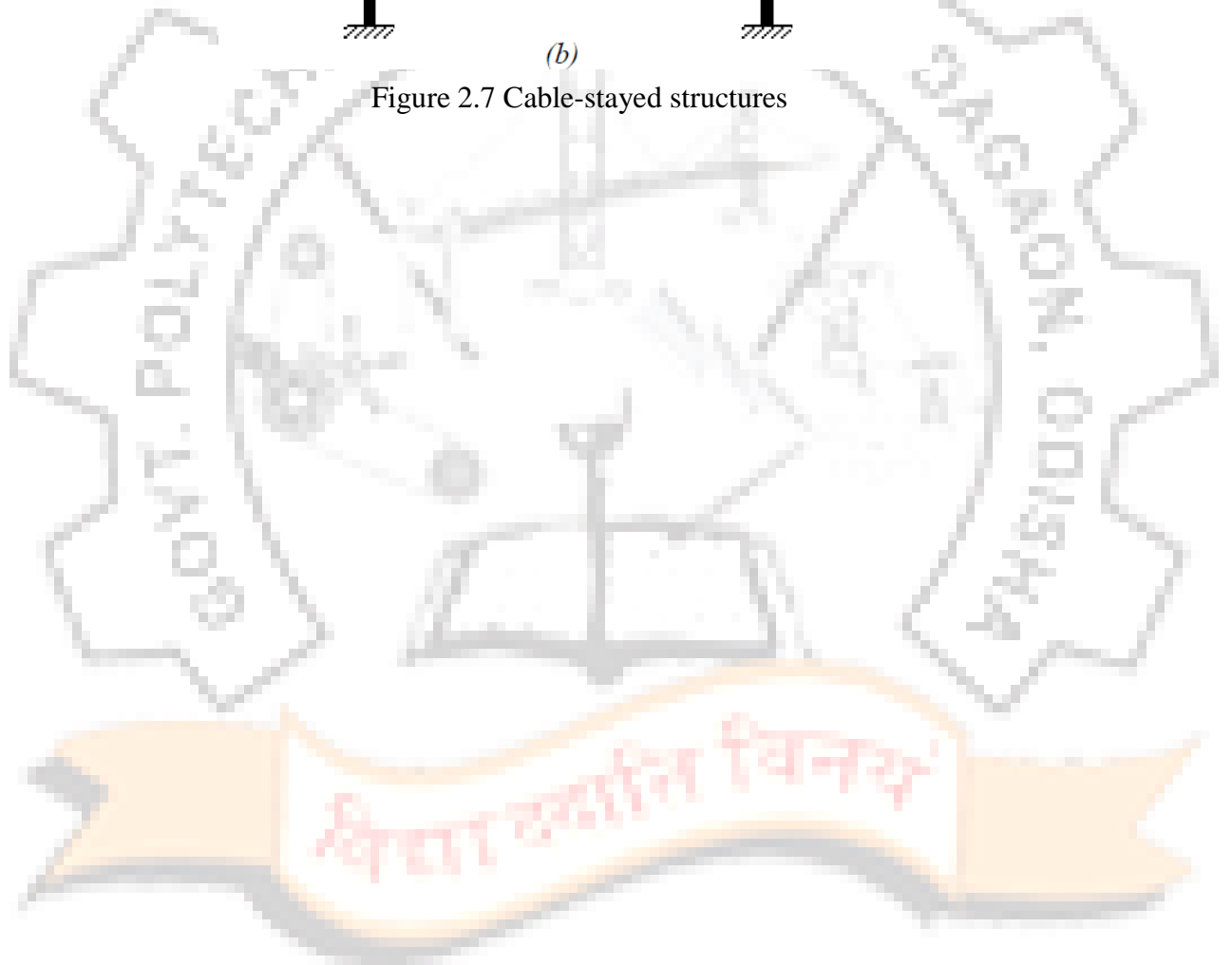

Lecture 3 Methods of design of steel structures

Introduction

A Designer has to ensure that the structures and facilities one designs are (i) fit for their purpose (ii) safe and (iii) economical and durable. Thus safety is one of the paramount responsibilities of the designer. However, it is difficult to assess at the design stage how safe a proposed design will actually be – consistent with economy. There is, in fact, a great deal of uncertainty about the many factors, which influence both safety and economy. Firstly, there is a natural variability in the material strengths and secondly it is impossible to predict the loading, which a structure (e.g. a building) may be subjected to on a future occasion. Thus uncertainties affecting the safety of a structure are due to

- uncertainty about loading
- uncertainty about material strength and
- uncertainty about structural dimensions and behaviour.

These uncertainties together make it impossible for a designer to guarantee that a structure will be absolutely safe. All that the designer could ensure is that the risk of failure is extremely small, despite the uncertainties.

An illustration of the statistical meaning of safety is given in Fig. 3.1. Let us consider a structural component (say, a beam) designed to carry a given nominal load. Bending moments (B.M.) produced by characteristic loads are first computed. These are to be compared with the characteristic resistance or strength (R.M.) of the beam. But the characteristic resistance (R.M.) itself is not a fixed quantity, due to variations in material strengths that might occur between nominally same elements. The actual resistance of these elements can be expected to vary as a consequence. The statistical distribution of these member strengths (or resistances) will be as sketched in (a).

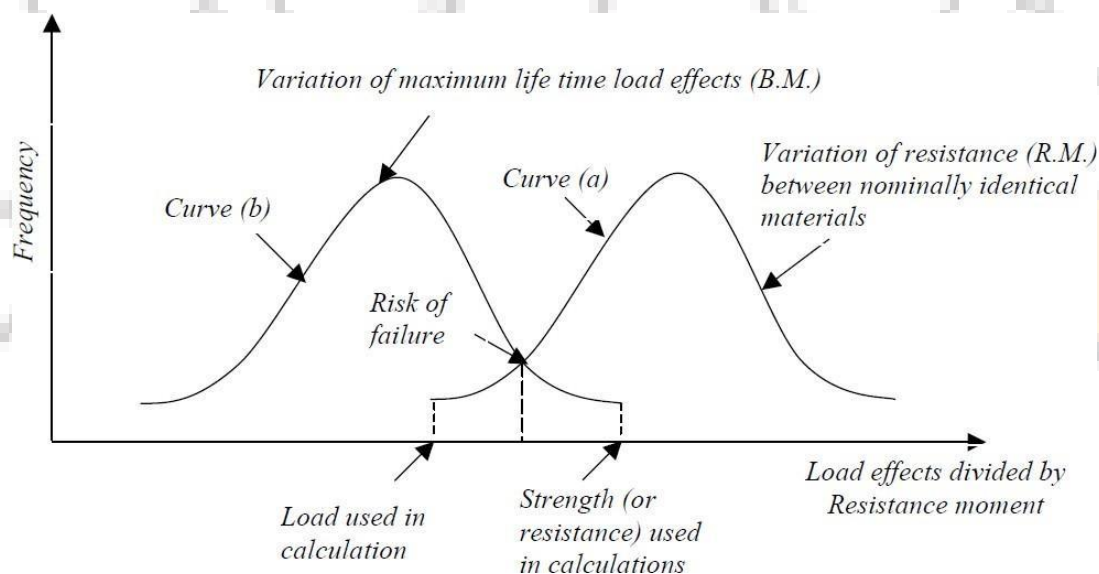

Figure 3.1 Statistical Meaning of Safety

Similarly, the variation in the maximum loads and therefore load effects (such as bending moment) which different structural elements (all nominally the same) might encounter in their service life would have a distribution shown in (b). The uncertainty here is both due to variability of the loads applied to the structure, and also due to the variability of the load distribution through the structure. Thus if a particularly weak structural component is subjected to a heavy load which exceeds the strength of the structural component, clearly failure could occur.

Unfortunately it is not practicable to define the probability distributions of loads and strengths, as it will involve hundreds of tests on samples of components. Normal design calculations are made using a single value for each load and for each material property and making appropriate safety factor into the design calculations. The value used is termed as “Characteristic Strength or Resistance” or “Characteristic Load”. Characteristic resistance of a material (such as Concrete or Steel) is defined as that value of resistance below which not more than a prescribed percentage of test results may be expected to fall. (For example the characteristic yield stress of steel is usually defined as that value of yield stress below which not more than 5% of the test values may be expected to fall). In other words, this strength is expected to be exceeded by 95% of the cases. Similarly, the characteristic load is that value of the load, which has an accepted probability of not being exceeded during the life span of the structure. Characteristic load is therefore that load which will not be exceeded 95% of the time.

Standardisation

Most structural designs are based on experience. Standardisation of all designs is unlikely within the foreseeable future hence design rules, based on experience, become useful. If a similar design has been built successfully elsewhere, there is no reason why a designer may not consider it prudent to follow aspects of design that have proved successful, and adopt standardised design rules. As the consequences of bad design can be catastrophic, the society expects designers to explain their design decisions. It is therefore advantageous to use methods of design that have proved safe in the past. Standardised design methods can help in comparing alternative designs while minimising the risk of the cheapest design being less safe than the others.

Most Governments attempt to ensure structural safety through regulations and laws. Designers then attempt to achieve maximum economy within the range of designs that the regulations allow. Frequently the professions are allowed to regulate themselves; in these cases the Regulations or Codes of Practices are evolved by consultation and consensus within the profession.

Allowable stress design (ASD)

With the development of linear elastic theories in the 19th century the stress-strain behaviour of new materials like wrought iron & mild steel could be accurately represented. These

theories enabled indeterminate structures to be analysed and the distribution of bending and shear stresses to be computed correctly. The first attainment of yield stress of steel was generally taken to be the onset of failure. The limitations due to non-linearity and buckling were neglected.

The basic form of calculations took the form of verifying that the stresses caused by the characteristic loads must be less than an “allowable stress”, which was a fraction of the yield stress. Thus the allowable stress may be defined in terms of a “factor of safety” which represented a margin for overload and other unknown factors which could be tolerated by the structure. The allowable stress is thus directly related to yield stress by the following expression:

$$\text{Allowable stress} = \text{Yield stress} / \text{Factor of Safety}$$

In general, each member in a structure is checked for a number of different combinations of loading. The value of factor of safety in most cases is taken to be around 1.67. Many loads vary with time and these should be allowed for. It is unnecessarily severe to consider the effects of all loads acting simultaneously with their full design value, while maintaining the same factor of safety or safety factor. Using the same factor of safety or safety factor when loads act in combination would result in uneconomic designs.

A typical example of a set of load combinations is given below, which accounts for the fact that the dead load, live load and wind load are all unlikely to act on the structure simultaneously at their maximum values:

(Stress due to dead load + live load) < allowable stress

(Stress due to dead load + wind load) < allowable stress

(Stress due to dead load + live load + wind) < 1.33 times allowable stress.

In practice there are severe limitations to this approach. These are the consequences of material non-linearity, non-linear behaviour of elements in the post-buckled state and the ability of the steel components to tolerate high theoretical elastic stresses by yielding locally and redistributing the loads. Moreover the elastic theory does not readily allow for redistribution of loads from one member to another in a statically indeterminate structures.

Limit state design

An improved design philosophy to make allowances for the shortcomings in the “Allowable Stress Design” was developed in the late 1970’s and has been extensively incorporated in design standards and codes formulated in all the developed countries. Although there are many variations between practices adopted in different countries the basic concept is broadly similar. The probability of operating conditions not reaching failure conditions forms the basis of “Limit States Design” adopted in all countries.

“Limit States” are the various conditions in which a structure would be considered to

have failed to fulfil the purpose for which it was built. In general two limit states are considered at the design stage and these are listed in Table 3.1.

Table 3.1: Limit States

Limit State of Strength	Serviceability Limit State
Strength (yield, buckling)	Deflection
Stability against overturning and sway	Vibration
Fracture due to fatigue	Fatigue checks (including reparable damage due to fatigue)
Plastic collapse	Corrosion
Brittle Fracture	Fire

“Limit State of Strength” are: loss of equilibrium of the structure and loss of stability of the structure. “Serviceability Limit State” refers to the limits on acceptable performance of the structure.

Not all these limits can be covered by structural calculations. For example, corrosion is covered by specifying forms of protection (like painting) and brittle fracture is covered by material specifications, which ensure that steel is sufficiently ductile.

Partial safety factor

The major innovation in the new codes is the introduction of the partial safety factor format. A typical format is described below:

In general calculations take the form of verifying that

$$S^* < R^*$$

where S^* is the calculated factored load effect on the element (like bending moment, shear force etc) and R^* is the calculated factored resistance of the element being checked, and is a function of the nominal value of the material yield strength. S^* is a function of the combined effects of factored dead, live and wind loads. (Other loads – if applicable, are also considered)

In accordance with the above concepts, the safety format used in Limit State Codes is based on probable maximum load and probable minimum strengths, so that a consistent level of safety is achieved. Thus, the design requirements are expressed as follows:

$$S_d \leq R_d$$

where S_d = Design value of internal forces and moments caused by the design Loads, F_d

$F_d = \gamma_f \cdot \text{Characteristic Loads.}$

γ_f = a load factor which is determined on probabilistic basis

R_d = Characteristic Value of Resistance/ γ_m

where γ_m = a material factor, which is also determined on a 'probabilistic basis'

It should be noted that γ_f makes allowance for possible deviation of loads and the reduced possibility of all loads acting together. On the other hand γ_m allows for uncertainties of element behaviour and possible strength reduction due to manufacturing tolerances and imperfections in the material.

Collapse is not the only possible failure mode. Excessive deflection, excessive vibration, fracture etc. also contribute to Limit States. Fatigue is an important design criterion for bridges, crane girders etc. (These are generally assessed under serviceability Limit States)

Thus the following limit states may be identified for design purposes:

- Ultimate Limit State is related to the maximum design load capacity under extreme conditions. The partial load factors are chosen to reflect the probability of extreme conditions, when loads act alone or in combination.
- Serviceability Limit State is related to the criteria governing normal use. Un-factored loads are used to check the adequacy of the structure.
- Fatigue Limit State is important where distress to the structure by repeated loading is a possibility.

The above limit states are provided in terms of partial factors reflects the severity of the risks.

An illustration of partial safety factors for applied load and materials as suggested in the revised IS: 800 for Limit States of Strength and Limit States of Serviceability are given in Table 3.2 and 3.3 respectively.

Factors governing the ultimate strength

Stability is generally ensured for the structure as a whole and for each of its elements. This includes overall frame stability against overturning and sway, as given below. The structure as a whole or any part of it are designed to prevent instability due to overturning, uplift or sliding under factored load as given below:

- a) The actions are divided into components aiding instability and components resisting instability.
- b) The permanent and variable actions and their effects causing instability are combined using appropriate load factors as per the Limit States requirements to obtain maximum destabilizing effect.

c) The permanent actions (loads) and effects contributing to resistance shall be multiplied with a partial safety factor 0.9 and added together with design resistance (after multiplying with appropriate partial safety factor). Variable actions and their effects contributing to resistance are disregarded.

d) The resistance effect shall be greater than or equal to the destabilizing effect. Combination of imposed and dead loads should be such as to cause most severe effect on overall stability.

Limit state of serviceability

As stated in IS: 800: 2007, Serviceability Limit State is related to the criteria, governing normal use. Serviceability limit state is limit state beyond which service criteria, specified below, are no longer met:

- a) Deflection Limit
- b) Vibration Limit
- c) Durability Consideration
- d) Fire Resistance

Load factor, γ_f , of value equal to unity are used for all loads leading to Serviceability Limit States to check the adequacy of the structure under serviceability limit states, unless specified otherwise.

The deflection under serviceability loads of a building or a building component should be such that, they do not impair the strength of the structure or components or cause damage to finishing. Deflections are to be checked for the most adverse but realistic combination of service loads and their arrangement, by elastic analysis, using a load factors as per Table 3.3. Table 3.4 gives recommended limits of deflections for certain structural members and systems.

As per IS: 800, suitable provisions in the design are required to be made for the dynamic effects of live loads, impact loads and vibration due to machinery operating loads. In severe cases possibility of resonance, fatigue or unacceptable vibrations shall be investigated.

Unusually flexible structures (generally the height to effective width of lateral load resistance system exceeding 5:1) need to be investigated for lateral vibration under dynamic wind loads.

Durability or Corrosion resistance of a structure is generally, under conditions relevant to their intended life as are listed below:

- a) The environment
- b) The degree of exposure
- c) The shape of the member and the structural detail
- d) The protective measure
- e) Ease of maintenance

Fire resistance of a steel member is a function of its mass, its geometry, the actions to which it is subjected, its structural support condition, fire protection measures adopted and the fire to which it is exposed.

Classification Of Cross-Sections

Determining the resistance (strength) of structural steel components requires the designer to consider first the cross sectional behaviour and second the overall member behaviour - whether in the elastic or inelastic material range, cross sectional resistance and rotation capacity are limited by the effects of local buckling.

In the IS 800: 2007 code cross sections are placed into four behavioural classes depending upon the material yield strength, the width to- thickness ratios of the individual components (e.g., webs and flanges) within the cross section, and the loading arrangement. The four classes of sections are defined as follows (see also Fig.3.2):

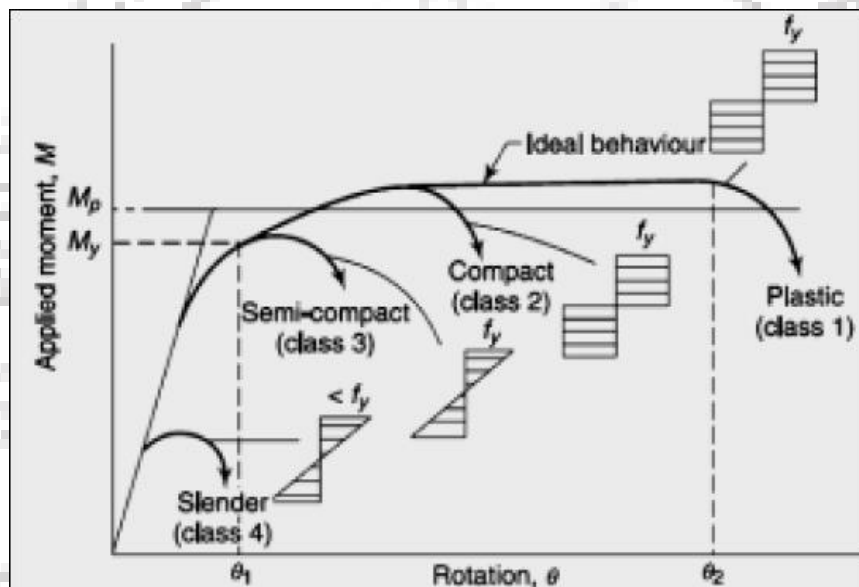

Figure 3.2: Moment-Rotation Behaviour Of The Four Classes Of Cross-Sections As Defined By IS 800: 2007

- (a) Plastic or class 1 Cross sections which can develop plastic hinges and have the rotation capacity required for the failure of the structure by the formation of a plastic mechanism (only these sections are used in plastic analysis and design).
- (b) Compact or class 2 Cross sections which can develop their plastic moment resistance, but have inadequate plastic hinge rotation capacity because of local buckling.
- (c) Semi-compact or class 3 Cross sections in which the elastically calculated stress in the extreme compression fibre of the steel member, assuming an elastic distribution of stresses,

can reach the yield strength, but local buckling is liable to prevent the development of the plastic moment resistance.

(d) Slender or class 4 Cross sections in which local buckling will occur even before the attainment of yield stress in one or more parts of the cross section. In such cases, the effective sections for design are calculated by deducting the width of the compression plate element in excess of the semi-compact section limit.

It has to be noted that only plastic sections should be used in indeterminate frames forming plastic-collapse mechanisms. In elastic design, semi-compact sections can be used with the understanding that the maximum stress reached will be M_y . Slender sections also have stiffness problems and are not preferable for hot-rolled structural steelwork. Compact or plastic sections are used for compression members, since they have more stiffness than semi-compact or slender members.

The maximum value of limiting width-thickness ratio of different classifications of sections is given by the code as shown in Table 3.5. When different elements of a cross section fall under different classifications, the most critical one has to be selected to represent the classification of the cross-section. Most of the hot-rolled sections available in the market fall under the category of plastic or compact sections.

Table 3.2: Partial safety factors for loads, γ_f for limit states

Combination (1)	Limit State of Strength					Limit State of Serviceability			
	DL (2)	LL ¹⁾		WL/EL (5)	AL (6)	DL (7)	LL ¹⁾		WL/EL (10)
		Leading (3)	Accompanying (4)				Leading (8)	Accompanying (9)	
DL+LL+CL	1.5	1.5	1.05	—	—	1.0	1.0	1.0	—
DL+LL+CL+	1.2	1.2	1.05	0.6	—	1.0	0.8	0.8	0.8
WL/EL	1.2	1.2	0.53	1.2	—	—	—	—	—
DL+WL/EL	1.5 (0.9) ²⁾	—	—	1.5	—	1.0	—	—	1.0
DL+ER	1.2 (0.9) ²⁾	1.2	—	—	—	—	—	—	—
DL+LL+AL	1.0	0.35	0.35	—	1.0	—	—	—	—

¹⁾ When action of different live loads is simultaneously considered, the leading live load shall be considered to be the one causing the higher load effects in the member/section.

²⁾ This value is to be considered when the dead load contributes to stability against overturning is critical or the dead load causes reduction in stress due to other loads.

Abbreviations:

DL = Dead load, LL = Imposed load (Live loads), WL = Wind load, CL = Crane load (Vertical/Horizontal), AL = Accidental load, ER = Erection load, EL = Earthquake load.

NOTE — The effects of actions (loads) in terms of stresses or stress resultants may be obtained from an appropriate method of analysis as in 4.

Table 3.3: Partial safety factors for materials γ_m

Sl No.	Definition	Partial Safety Factor	
i)	Resistance, governed by yielding, γ_{m0}	1.10	
ii)	Resistance of member to buckling, γ_{m0}	1.10	
iii)	Resistance, governed by ultimate stress, γ_{m1}	1.25	
iv)	Resistance of connection:	<i>Shop Fabrications</i>	<i>Field Fabrications</i>
a)	Bolts-Friction Type, γ_{mf}	1.25	1.25
b)	Bolts-Bearing Type, γ_{mb}	1.25	1.25
c)	Rivets, γ_{mr}	1.25	1.25
d)	Welds, γ_{mw}	1.25	1.50

Table 3.4 Deflection Limits

Type of Building	Deflection	Design Load	Member	Supporting	Maximum Deflection
(1)	(2)	(3)	(4)	(5)	(6)
Industrial Buildings	Vertical	Live load/ Wind load	Purlins and Girts	Elastic cladding	Span/150
				Brittle cladding	Span/180
		Live load	Simple span	Elastic cladding	Span/240
				Brittle cladding	Span/300
		Live load	Cantilever span	Elastic cladding	Span/120
				Brittle cladding	Span/150
		Live load/ Wind load	Rafter supporting	Profiled Metal Sheeting	Span/180
				Plastered Sheeting	Span/240
		Crane load (Manual operation)	Gantry	Crane	Span/500
		Crane load (Electric operation up to 50 t)	Gantry	Crane	Span/750
Crane load (Electric operation over 50 t)	Gantry	Crane	Span/1 000		

Asstt. Professor, VIT-AP

Other Buildings	Lateral	No cranes	Column	Elastic cladding	Height/150
		Crane + wind	Gantry (lateral)	Masonry/Brittle cladding	Height/240
				Crane (absolute)	Span/400
		Crane+ wind	Column/frame	Relative displacement between rails supporting crane	10 mm
				Gantry (Elastic cladding; pendent operated)	Height/200
		Vertical	Live load	Floor and Roof	Gantry (Brittle cladding; cab operated)
	Elements not susceptible to cracking				Span/300
	Live load		Cantilever	Elements susceptible to cracking	Span/360
				Elements not susceptible to cracking	Span/150
	Lateral	Wind	Building	Elements susceptible to cracking	Span/180
Elastic cladding				Height/300	
Lateral	Wind	Inter storey drift	Brittle cladding	Height/500	
			—	Storey height/300	

Table 3.5 Limiting Width to Thickness Ratio

Compression Element		Ratio	Class of Section			
			Class 1 Plastic	Class 2 Compact	Class 3 Semi-compact	
(1)		(2)	(3)	(4)	(5)	
Outstanding element of compression flange	Rolled section	b/t_f	9.4ϵ	10.5ϵ	15.7ϵ	
	Welded section	b/t_e	8.4ϵ	9.4ϵ	13.6ϵ	
Internal element of compression flange	Compression due to bending	b/t_f	29.3ϵ	33.5ϵ	42ϵ	
	Axial compression	b/t_f	Not applicable			
Web of an I, H or box section	Neutral axis at mid-depth		d/t_w	84ϵ	105ϵ	126ϵ
	Generally	If r_1 is negative:	d/t_w	$\frac{84\epsilon}{1+r_1}$	$\frac{105.0\epsilon}{1+r_1}$	$\frac{126.0\epsilon}{1+2r_1}$
		If r_1 is positive :	d/t_w	but $\leq 42\epsilon$	$\frac{105.0\epsilon}{1+1.5r_1}$ but $\leq 42\epsilon$	but $\leq 42\epsilon$
	Axial compression		d/t_w	Not applicable		42ϵ
Web of a channel		d/t_w	42ϵ	42ϵ	42ϵ	

Angle, compression due to bending (Both criteria should be satisfied)	b/t d/t	9.4ϵ 9.4ϵ	10.5ϵ 10.5ϵ	15.7ϵ 15.7ϵ
Single angle, or double angles with the components separated, axial compression (All three criteria should be satisfied)	b/t d/t $(b+d)/t$	Not applicable		15.7ϵ 15.7ϵ 25ϵ
Outstanding leg of an angle in contact back-to-back in a double angle member	d/t	9.4ϵ	10.5ϵ	15.7ϵ
Outstanding leg of an angle with its back in continuous contact with another component	d/t	9.4ϵ	10.5ϵ	15.7ϵ
Stem of a T-section, rolled or cut from a rolled I-or H-section	D/t_f	8.4ϵ	9.4ϵ	18.9ϵ
Circular hollow tube, including welded tube subjected to: a) moment b) axial compression	D/t	$42\epsilon^2$	$52\epsilon^2$	$146\epsilon^2$
	D/t	Not applicable		$88\epsilon^2$

NOTES

1 Elements which exceed semi-compact limits are to be taken as of slender cross-section.

2 $\epsilon = (250 / f_y)^{1/2}$.

3 Webs shall be checked for shear buckling in accordance with 8.4.2 when $d/t > 67\epsilon$, where, b is the width of the element (may be taken as clear distance between lateral supports or between lateral support and free edge, as appropriate), t is the thickness of element, d is the depth of the web, D is the outer diameter of the element (see Fig. 2, 3.7.3 and 3.7.4).

4 Different elements of a cross-section can be in different classes. In such cases the section is classified based on the least favourable classification.

5 The stress ratio r_1 and r_2 are defined as:

$$r_1 = \frac{\text{Actual average axial stress (negative if tensile)}}{\text{Design compressive stress of web alone}}$$

$$r_2 = \frac{\text{Actual average axial stress (negative if tensile)}}{\text{Design compressive stress of overall section}}$$



Structural elements

A building structure consisting of a steel frame work skeleton is made up of the following structural elements or members

- i) Flexural members; beams or girders
- ii) Tension members
- iii) Compression members: columns, stanchions, struts
- iv) Torsional members
- v) Elements of foundation structure

Some elements or members may be subjected to combined bending and axial loads. The members of steel frame are jointed together by riveted, bolted, pinned or welded connections or joints. No matter how complicated a structure may appear to be, it must consist of some combination of the basic members mentioned above. However, flexural members, (or beams) may, in some cases, appear as extremely heavy built-up girders and the compression members (or columns) and tension members (or ties) may be combined to form heavy trusses in an extensive frame work. The structural elements are made up of the following commonly used structural shapes and built-up sections as shown in Figure 4.1 below.

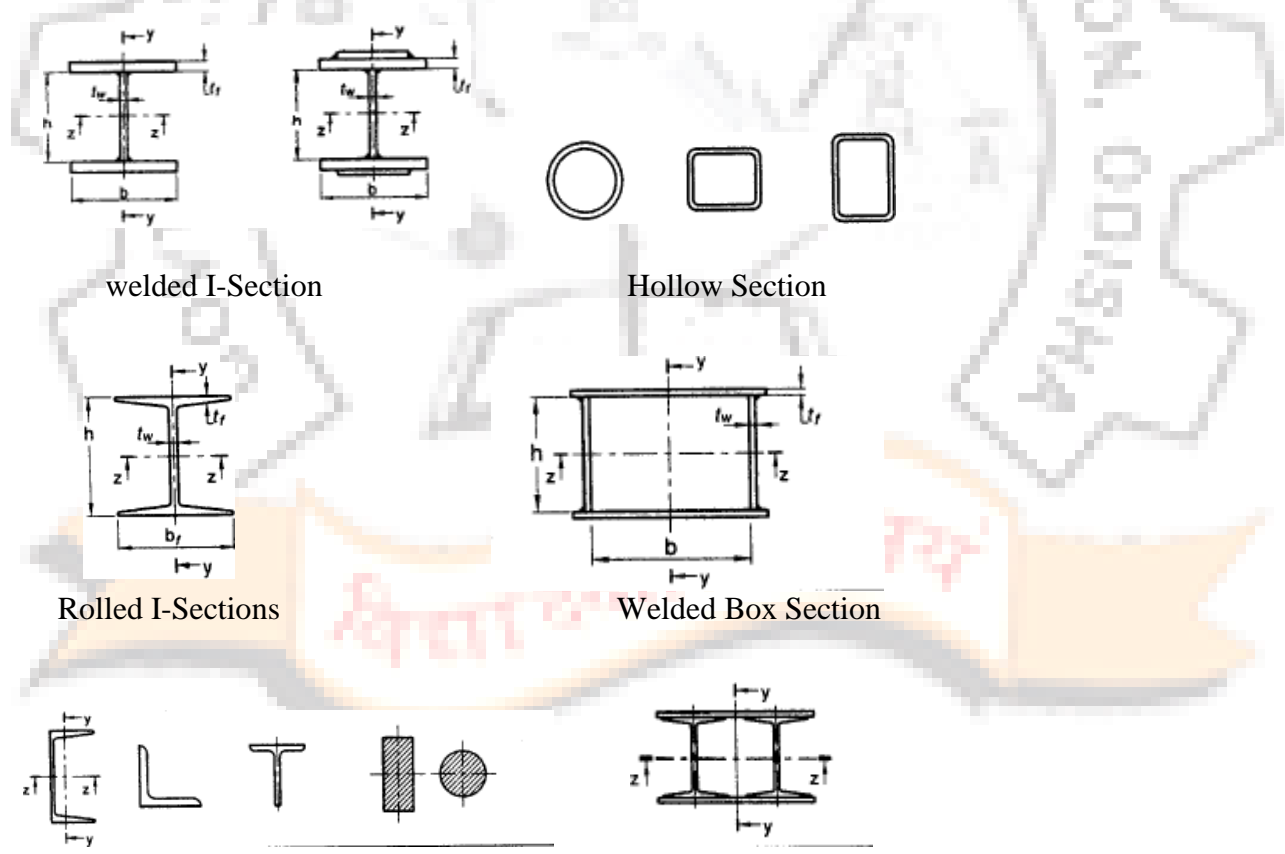

Channel, Angle, T and Solid Sections

Built-upMember

Figure 4.1 Commonly used structural shapes

- i) Angle section
- ii) T-section
- iii) Channel section
- iv) I-section
- v) Z-section
- vi) Solid square section
- vii) Square tube
- viii) Circular section (solid)
- ix) Hollow circular section
- x) Plate section
- xi) Compound and built-up sections

Beams and Girders

A beam is a structural member the primary function of which is to support loads normal to its axis. The word beam and the word girder are used more or less interchangeably. However, the word girder may mean either a built-up member (usually a heavy one) or a main beam (single rolled shaped or built-up) which supports other beams. In a beam, loads are resisted by bending and shear, but local stress conditions and deflection are also important considerations. Beams in structures may also be referred to by typical names that suggest their function in the structure as given below:

- i) Girder : Usually indicate a major beam frequently at wide spacing that supports small beams
- ii) Joists : Closely spaced beams supporting the floors and roofs of buildings
- iii) Purlins : Roof beams usually supported by trusses
- iv) Rafters : Roof beams usually supported by purlins
- v) Lintel : Beam over window or door openings that support the wall above
- vi) Girts: :Horizontal wall beams used to support wall covering on the side of an industrial building
- vii) Spandrel beam :Beam around the outside perimeter of a floor that support the exterior walls and the outside edge of the floor

Tension Members

A tension member is the one which is intended to resist axial tension. Tension members are also called ties or hangers. The cross-sectional arrangement of material in axially stressed tension members is structurally unimportant.

Compression members

Compression members also called columns, struts, posts or stanchions are intended primarily to resist compressive stress. The requirements for compression members are more demanding than those for tension members, since in this case the carrying capacity is a function of shape

as well as of area and material properties. The buckling of the column in any possible direction becomes a governing criterion.



Structural steel sections

Structural steel is rolled into a variety of shapes and sizes. The shapes are designated by the shape and size of their cross-section. Following are various types of rolled structural steel sections commonly used:

- i) Rolled steel beam sections (I-section)
- ii) Rolled steel channel sections
- iii) Rolled steel angle sections
- iv) Rolled steel T-sections
- v) Rolled steel bars
- vi) Rolled steel plates
- vii) Rolled steel sheets and strips
- viii) Mild steel flats

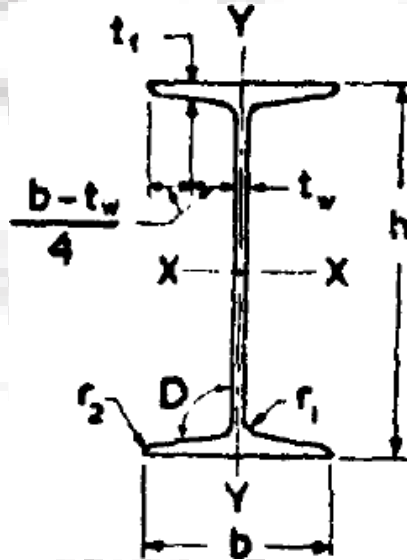

Figure 5.1 Rolled steel I beam

1. Rolled steel beam section (Figure 5.1)
ISI Hand Book for Structural Engineers Vol 1: Structural steel sections gives five series of beam section
 - i) Junior beams, designated as ISJB (Indian Standard Junior Beams)
 - ii) Light Beams designated as ISLB (Indian Standard Light Beams)
 - iii) Medium Beams, designated as ISMB (Indian Standard Medium Weight Beams)
 - iv) Wide Flange Beams, designated as ISWB (Indian Standard Wide-Flange Beams)
 - v) H-Beams or column beams designated as ISHB (Indian Standard H-Beams)

Each beam section is designated by the series to which it belongs followed by the depth (in mm) of the section. For example, ISMB 400 means a beam section of medium weight and of depth equal to 400 mm. In some cases of wide flange beams and H-beams, more than one

section is available for the same depth. For example, more than one section is available for the same depth. For example, there are two sections of ISWB600; these two sections are differentiated by writing the mass of the beams per m run. Thus we have ISWB 600 @133.7 kg/m and ISWB 600@145.1 kg/m both of these being two different sections having different properties. Similarly we have ISHB 300@58.8 kg/m and ISHB 300@63.0 kg/m giving two different sections having different geometrical properties.

2. Rolled Steel Channel Sections (Figure 5.2)

ISI hand book gives the following four series of channel sections:

- i) Junior channels designated by ISJC (Indian Standard Junior Channels)
- ii) Light Channels designated by ISLC (Indian Standard Light Channels)
- iii) Medium channels designated by ISMC (Indian Standard Medium Weight Channels)
- iv) Special channels designated by ISSC (Indian Standard Special Channels)

Each rolled steel section is designated by the series to which it belongs, followed by its depth (in mm) and then its mass per metre length. Thus we have ISLC 400@45.7 Kg/m, meaning thereby that it is a light channel, having depth equal to 400 mm and mass equal to 45.7 kg/m. A channel section has only one axis of symmetry. Due to this, it is subjected to twisting or torsion, along with bending, when used as a beam.

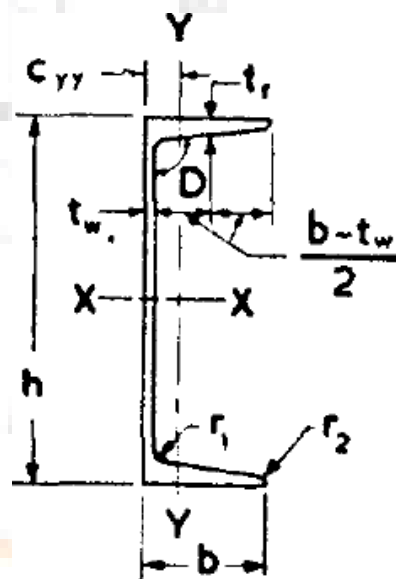

Figure 5.2 Rolled steel channel

3. Rolled Steel Angle Sections (Figure 5.3)

ISI hand book gives three series of angle sections:

- i) Equal angles section designated by ISA (Indian Standard Equal Angles)
- ii) Unequal angles section designated by ISA (Indian Standard Unequal Angles)
- iii) Bulb angle section designated by ISBA (Indian Standard Bulb angles) (Figure 5.4)

Since the equal angle section and unequal angle section are designated by the same series, the width and height of the legs of the angle are also mentioned along with the series. Thus, ISA

4040 will mean an equal angle section, having width and depth equal to 40 mm. Similarly ISA 4025 will mean an unequal angle section having depth equal to 40 mm and width equal to 25 mm. A bulb angle has unequal legs and hence only its depth is mentioned along with the series designation. Thus we have ISBA 300 meaning there by that it is a bulb angle section having its depth equal to 300 mm. However, there may be two bulb sections of the same depth, and these are differentiated by mentioning their mass per metre length. Thus we have ISBA 300 @ 47.5 kg/m and ISBA 300 @ 52.6 kg/m giving two sections which have different properties. It should be noted that the angle sections mentioned above do not have any axis of symmetry and hence the principal axes u-u and v-v are inclined to x-x and y-y axes.

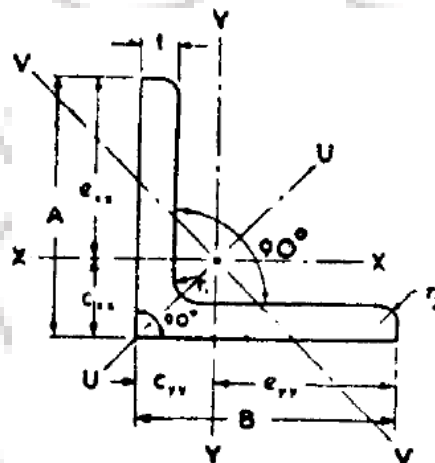

Figure 5.3 Rolled steel angle

4. Rolled Steel T-sections (Figure 5.5)

- i) Normal Tee designated by ISNT, having width of flange, equal to the depth of section
- ii) H-Tee or wide flange tee, designated by ISHT, having width of flange equal to twice the depth of the section.
- iii) Short-Tee designated by ISST, having the width of flange shorter than the depth of the section
- iv) Light-Tee, designated by ISLT, having light weight
- v) Junior Tee designated by ISJT

Each T-section is designated by the series to which it belongs followed by the depth in mm. Thus we have ISNT 100, meaning there by that it is a normal Tee section, having its depth equal to 100 mm. Similarly ISLT 100 will mean a light Tee section having depth of section equal to 100 mm. It is always preferable to mention the mass per metre length also such as ISNT 100 @ 15.0 kg/m or ISST 200 @ 28.4 kg/m etc.

5. Rolled Steel Bar Sections (Figure 5.6)

ISI Hand book gives rolled steel bars of two types:

- i) Round bars designated by ISRO
- ii) Square bars designated by ISSQ

Each bar section is designated by the series to which it belongs along with the diameter or the width in mm. Thus ISRO 100 will mean a round bar having 100 mm diameter. Similarly ISSQ 80 will mean a square bar of size 80 mm.

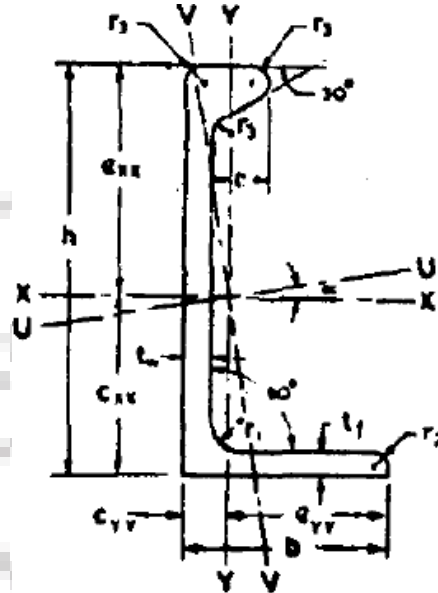

Figure 5.4 Rolled steel bulb angle

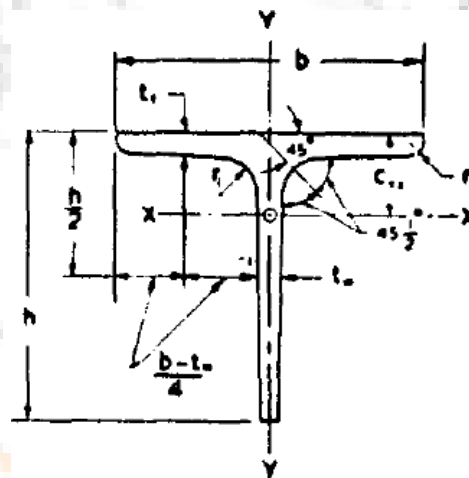

Figure 5.5 Rolled steel Tee bars



Figure 5.6 Square and round bars

Types of Connections

A structure is an assembly of various elements or components which are fastened together through some type of connection. If connections are not designed properly and fabricated with care, there may be a source of weakness in the finished structure, not only in their structural action but also because they may be the focus of corrosion and aesthetically unpleasing. Where as the design of main members has reached an advanced stage, based upon theories which have been developed and refined, the behaviour of connections is often so complex that theoretical considerations are of little use in practical design. By their very nature, connections are a jumble of local effects. Most connections are highly indeterminate, with the distribution of stress depending upon the deformation of fasteners and the detail material. Local restraints may prevent the deformation necessary for desirable stress redistribution.

Following are the requirements of a good connection in steelwork:

1. It should be rigid, to avoid fluctuating stresses which may cause fatigue failure
2. It should be such that there is the least possible weakening of the parts to be joined
3. It should be such that it can be easily installed, inspected and maintained.

The following are the common types of connections used for structural steel work;

1. Riveted connections
2. Bolted connections
3. Pinned connections
4. Welded connections

Rivets, bolts and welds are used extensively, and frequently the economic advantage of one over the other two is so small to be uncertain. However, at one time, riveting prevailed but it has been superseded in importance by welding and high-strength bolting.

Historical Notes on Rivets

Rivets were the accepted method for connecting the members of steel structures for many years. Today however they no longer provide the most economical connections and are obsolete. It is doubtful that you could find a steel fabricator who can do riveting. It is however desirable for the designer to be familiar with rivets even though he or she will probably never design riveted structures. He or she may have to analyze an existing riveted structure for new loads or for an expansion of the structure. The purpose of these sections is to present only a very brief introduction to the analysis and design of rivets. One advantage of studying these obsolete connectors is that while doing so you automatically learn how to analyze common bolts. These bolts are handled exactly as are rivets except that the design stresses are slightly different.

Rivet and Riveting

Riveting is a method of joining together structural steel components by inserting ductile metal pins, called rivets, into holes of the components to be connected from coming apart. A rivet consists of (i) a shank of given length and diameter and (ii) a head known as manufactured head. The size of the rivet is defined by the diameter of the shank. Riveting is essentially a forging process during which a hot rivet is driven in its plastic state and a head is formed at the other end. The head so formed at the other end of the rivet with the help of a riveting hammer and a buckling bar is known as driven head.

Rivets driven in the field during the erection of a structure are known as field rivets. Rivets driven in the fabricating shop are known as shop rivets. Both these types are known as hot driven rivets since the rivets are heated to a temperature ranging between 1000°F to 1950°F before driving. Field rivets are driven by a hand operated pneumatic riveting hammer, while the shop rivets are driven by "bull" riveter. Some rivets are driven at atmospheric temperature. They are known as cold driven rivets which are squeezed or driven to fill the holes and to form the heads by application of large pressure. However, they are smaller in diameter, ranging from 12 mm to 22 mm. Strength of cold driven rivet is more than hot driven rivets. Rivets driven by hand operated riveting hammer are known as hand driven rivets while those driven by power operated equipment are known as power driven rivets. Some times, even the field rivets may also be power driven.

Types of Riveted Joints

There are two types of riveted or bolted joints.

- i) Lap joint: The first is the lap joint in which the plates to be connected overlap each other. (Figure 6.1)
- ii) Butt joint: The second is the butt joint in which the plates are to be connected butt against each other and the connection is made by providing a cover plate on one or both sides of the joint. (Figure 6.2)

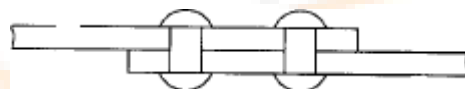

Figure 6.1 Single Riveted lap joint

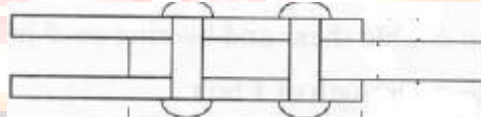

Figure 6.2 Double riveted butt joint

Definitions

The following definitions are used for riveted or bolted joints

- i) Nominal diameter: The diameter of the shank of a rivet before riveting is called the nominal diameter.

- ii) Effective diameter or gross diameter: The effective or gross diameter of a rivet is equal to the diameter of the hole it fills after riveting
- iii) Gross area: The gross area of a rivet is given by its gross diameter.
- iv) Pitch: The distance between centres of any two adjacent rivets is called the pitch.
- v) Gauge: A row of rivets parallel to the direction of force is called a gauge line. The normal distance between two adjacent gauge lines is called the gauge distance.
- vi) Edge distance; It is the distance between the edge of a member or cover plate and the centre of the nearest rivet hole.

Failure of a riveted joint (Figure 6.3)

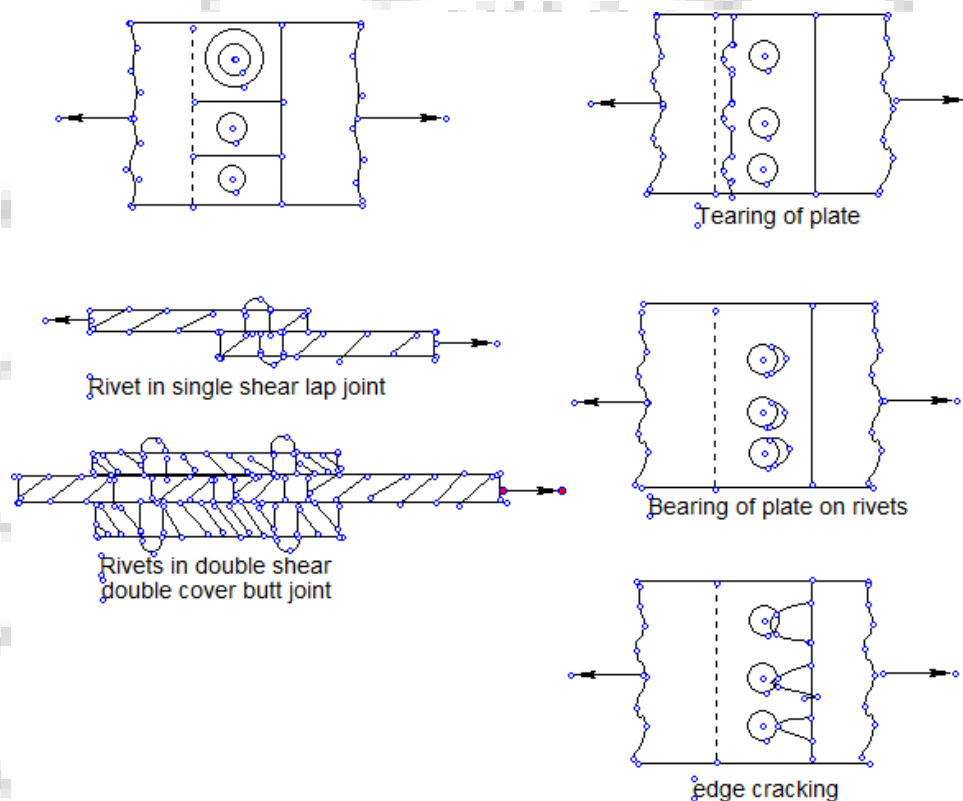

Figure 6.3: Failure of Riveted joints

Consider a riveted joint shown in Figure 6.3. The joint may fail in any of the following manners.

- i) Tearing of the plate between rivet holes: The strength of the plate is reduced by rivet holes and the plate may tear off along the line of the rivet holes as shown in Figure b. This type of failure is for tension members only.
- ii) Shearing of rivet: The rivets fail by shearing if the shearing stress exceeds their shearing strength. In lap joints and single cover butt joints, the rivets are sheared at one plane only. In a double cover butt joint, the rivets are sheared at two planes as shown in Figure c.
- iii) Bearing of plate or rivet: The plate or rivet is crushed if the compressive stress exceeds the bearing strength of the plate or the rivet as shown in Figure d.

- iv) Edge cracking; The plate will crack at the back of a rivet if it is placed very near to the edge of the plate as shown in figure e. This failure is prevented if the minimum edge distances are provided.

The first three types of failures determine the strength of a joint. The rivet value or strength of rivet is determined by the types of failure described in shearing and bearing of rivets.

Assumptions in the theory of riveted joints

Certain assumptions are made while deriving expressions for the strength of riveted joints as follows:

- i) The tensile stress is uniformly distributed on the portions of the plate between the rivets.
- ii) The friction between the plates is neglected.
- iii) The shearing stress is uniformly distributed on the cross-sections of the rivets.
- iv) The rivets fill the holes completely.
- v) The rivets in a group share the direct load equally
- vi) Bending stress in rivets is neglected

Strength of a Riveted Joint

Consider one pitch p of the riveted joint as shown in Figure 6.3 a.

Strength of joint per pitch = smaller of i) the strength of plate between rivet holes in tension and ii) rivet value

i) Strength of plate between rivet holes in tension = $\sigma_{at}(p - d)t$

ii) Rivet value = smaller of the bearing strength and shearing strength of rivet

Bearing strength of rivet = $\sigma_{pf}dt$ or $\sigma_p dt$ whichever is smaller

Shearing strength of rivet = $\tau_{vf} \frac{\pi}{4} d^2$ in single shear

= $2\tau_{vf} \frac{\pi}{4} d^2$ in double shear

Where σ_{at} is the allowable tensile stress in an axially loaded tension member

σ_p is the allowable bearing stress in the member

σ_{pf} is the allowable bearing stress in the rivets

τ_{vf} is the allowable shear stress in the rivets

p is the pitch

d is the diameter of the rivet

t is the thickness of the thinner part

t is the thickness of the main plate or the total thickness of cover plates, whichever is smaller.

Efficiency of a joint

The original strength of a section is reduced by rivet holes. The efficiency of a joint is the ratio of the joint and the original strength of the member without rivet holes. At the weakest critical section, the number of rivet holes should be minimum for maximum efficiency.

Design of riveted joints for axially loaded members

The diameter of a rivet is generally calculated by the following formula;

$$d = 6\sqrt{t} \text{ where } d \text{ is the rivet diameter in mm and } t \text{ is the thickness of plate in mm}$$

Number of rivets required for the joint = Load/Rivet value

The rivets are arranged bearing in mind the following points:

- i) The arrangement should satisfy the gauge, pitch and edge distance requirements
- ii) The strength of joint should be increased gradually towards the joint for uniform distribution of stress in the rivets.
- iii) The cg of each rivet group should coincide with the centreline of the connected members. It is not possible practically to follow this condition in some cases e.g the angle connection with gusset plate. The small eccentricities are usually neglected.
- iv) The centreline of all members meeting at a joint should coincide at one point only otherwise the joint will twist out of position,
- v) The strength of member reduces due to rivet holes. The reduction in area due to rivet holes is minimum if rivets are arranged in a zig-zag form.

Design example

Figure 6.4 shows a joint in the lower chord of a roof truss. Design the riveted connections if the permissible stresses are:

$$\sigma_{at} = 150 \text{ MPa}$$

$$\sigma_{pf} = 250 \text{ MPa}$$

$$\tau_{vf} = 80 \text{ MPa}$$

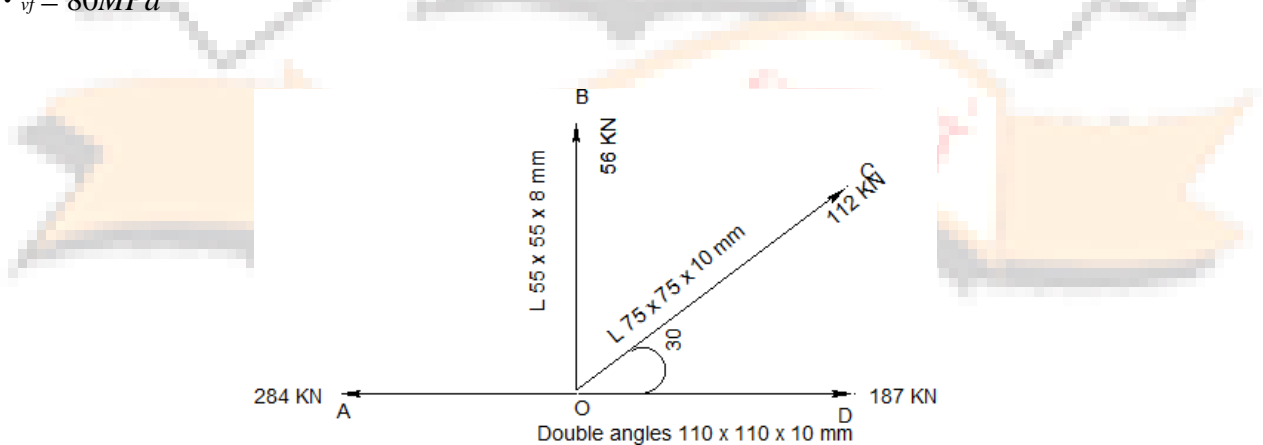

Figure 6.4 A truss joint

Table 6.1 Rivet diameter pitch and edge distances

Nominal dia of rivets (mm)	12	14	16	18	20	22	24	27	30
Gross dia of rivets	13.5	15.5	17.5	19.5	21.5	23.5	25.5	29	32
Minimum edge distance for sheared or rough edge	19	25	29	32	32	38	44	51	57
Minimum edge distance for rolled or planed edge	17	22	25	29	29	32	38	44	51

Minimum pitch = 2.5 times the diameter of the rivet hole

Maximum pitch = 32 t or 300 mm whichever is less

Solution: Using a gusset plate 12 mm thick

Diameter of rivets = $6\sqrt{t} = 18.9$ (say 20 mm)

Gross diameter of rivets = $20 + 1.5 = 21.5$ mm (Table 6.1)

Member OB

$$\text{Strength of rivets in bearing on 8 mm thick angle} = \frac{250 \times 21.5 \times 8}{1000} = 43 \text{ KN}$$

$$\text{Strength of rivet in single shear} = \frac{80}{1000} \times \frac{\pi}{4} \times (21.5)^2 = 29 \text{ KN}$$

Rivet value = 29 KN

Number of rivets required = $56/29 = 1.9$ (say 2 rivets)

Member OC

$$\text{Strength of rivets in bearing on 10 mm thick angle} = \frac{250 \times 21.5 \times 10}{1000} = 53.75 \text{ KN}$$

$$\text{Strength of rivet in single shear} = \frac{80}{1000} \times \frac{\pi}{4} \times (21.5)^2 = 29 \text{ KN}$$

Rivet value = 29 KN

Number of rivets required = $112/29 = 3.86$ (say 4 rivets)

Member AD

$$\text{Strength of rivets in bearing on 12 mm thick gusset} = \frac{250 \times 21.5 \times 12}{1000} = 64.5 \text{ KN}$$

$$\text{Strength of rivet in double shear} = \frac{2 \times 80}{1000} \times \frac{\pi}{4} \times (21.5)^2 = 58 \text{ KN}$$

Rivet value = 58 KN

Number of rivets required = Difference of force in member AO & OD/58 = (284-187)/58=1.6
(say 2 rivets)

For all rivets adopt pitch = 3D = 3×21.5 = 64.5 (say 65 mm)

Edge distance = 2D = 43 mm (say 45 mm)

The arrangements are shown as below in Figure 6.5.

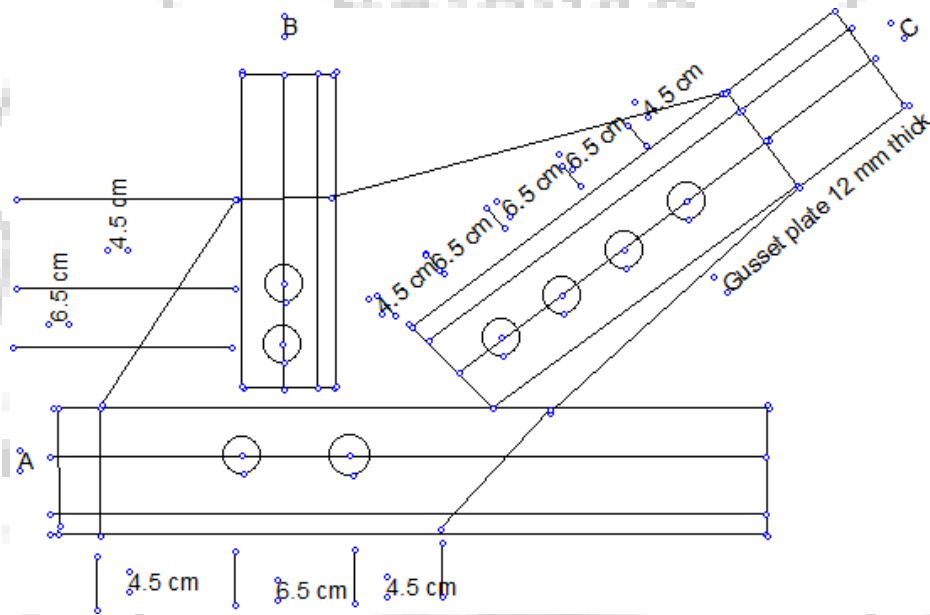

Figure 6.5 Design of a riveted joint

विद्या ऽ मृतमश्नुते विनायक



Welded Connections

Introduction

Steel sections are manufactured and shipped to some standard lengths, as governed by rolling, transportation and handling restrictions. However, most of the steel structural members used in structures have to span great lengths and enclose large three dimensional spaces. Hence connections are necessary to synthesize such spatial structures from one- and two-dimensional elements and also to bring about stability of structures under different loads. Thus, connections are essential to create an integral steel structure using discrete linear and two-dimensional (plate) elements.

A structure is only as strong as its weakest link. Unless properly designed, the connections joining the members may be weaker than the members being joined. However, it is desirable to avoid connection failure before member failure for the following reasons:

- To achieve an economical design, usually it is important that the connections develop the full strength of the members.
- Usually connection failure is not as ductile as that of steel member failure. Hence it is desirable to avoid connection failure before the member failure.

Therefore, design of connections is an integral and important part of design of steel structures. They are also critical components of steel structures, since

- They have the potential for greater variability in behaviour and strength,
- They are more complex to design than members, and
- They are usually the most vulnerable components, failure of which may lead to the failure of the whole structure.

Thus designing for adequacy in strength, stiffness and ductility of connections will ensure deflection control during service load and larger deflection and ductile failure under overload. Hence, a good understanding of the behaviour and design of joints and connections in steel structures is an important pre-requisite for any good design engineer.

Welded connections are direct and efficient means of transferring forces from one member to the adjacent member. Welded connections are generally made by melting base metal from parts to be joined with weld metal, which upon cooling form the connection. The welded connections in a majority of the cases may be categorised as fillet weld or butt (or groove) welds as shown in Fig. 7.1.

Fillet welds, as shown in Fig. 7.1(a), are made against two surfaces of adjacent plates to join them together. The merits of the fillet welds are:

- no prior edge preparation is necessary,
- simple, fast and economical to make, and
- does not require very skilled labour.

The demerits of fillet welds are:

- not appropriate to transfer forces large in magnitude,
- poorer performance under fatigue loading, and
- less attractive in appearance.

Butt welds, as shown in Fig. 7.1(b), are made by butting plate surfaces against one another and filling the gap between contact surfaces with weld metal, in the process fusing the base metal also together. In order to ensure full penetration of the weld metal, normally the contact surfaces are cambered to obtain gap for the weld metal to flow easily.

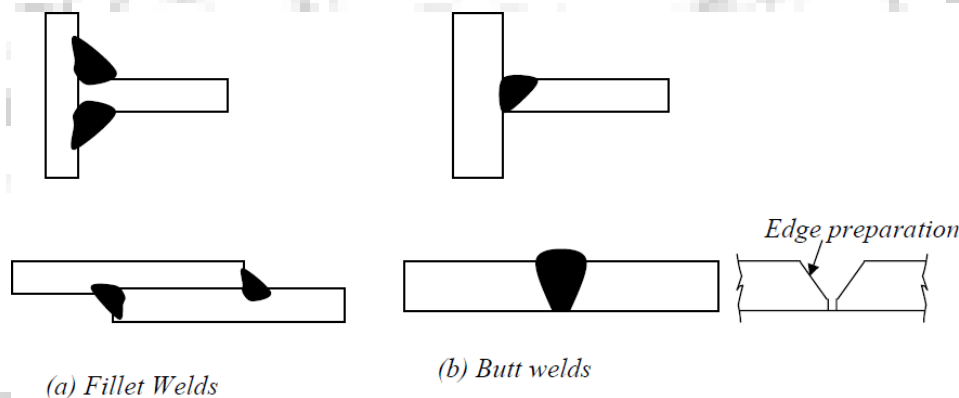

Figure 7.1 Typical welded connections

The merits of butt welds are:

- easily designed and fabricated to be as strong as the member,
- better fatigue characteristics, compared to fillet welds,
- better appearance, compared to fillet welds, and
- easy to detail and the length of the connection is considerably reduced.

The demerits of the butt welds are:

- more expensive than fillet welds because of the edge preparation required, and
- require more skilled manpower, than that required for filled welds.

It has been pointed out that steel sections are linear elements produced in certain convenient lengths due to constraints on manufacturing and transportation. Therefore connections are necessary to provide continuity, where required, as well as to create three-dimensional steel

structures. One of the most efficient and possibly direct ways of providing connections in steel structures is by way of welding. Welding is the process of joining two pieces of metal by creating a strong metallurgical bond between them by heating or pressure or both. It is distinguished from other forms of mechanical connections, such as riveting or bolting, which are formed by friction or mechanical interlocking. It is one of the oldest and reliable methods of jointing. Welding was quite an art prevalent in ancient Greece to make bracelets. It was probably a forging process, where metals were heated and hammered together. Modern welding has been in existence since World War I. It was mainly used for repairing damaged ships. After 1919, the use of welding as a construction and fabrication method began to develop. Since then many improvements and developments have taken place. Today there are over 50 different welding processes, which can be used to join various metals and their alloys.

Advantages of welding

Welding offers many advantages over bolting and riveting. Some of the advantages are listed in the following.

- Welding enables direct transfer of stress between members. Hence, the weight of the joint is minimum. Besides efficiency, design details are very simple. Less fabrication cost compared to other methods due to handling of fewer parts and elimination of operations like drilling, punching etc. The most striking advantage of welded structures is in the area of economy. Welded structures allow the elimination of a large percentage of the gusset and splice plates necessary for riveted or bolted structures. Time is saved in detailing, fabrication and field erection. In some bridge trusses it may be possible to save up to 15% of the steel weight by resorting to welding. Welding also requires considerably less labour for executing the work.
- Welding offers air tight and water tight joining of plates and hence ideal for oil storage tanks, ships etc.
- Welded structures usually have a neat appearance as against the cluttered surface of bolted or riveted connections. Fig. 7.2 shows a comparison of riveted plate girder and a welded plate girder. Further, welded connections offer the designer more freedom for innovation in his design concept. It enables him to use any cross section and the best configuration to transmit forces from one member to another.

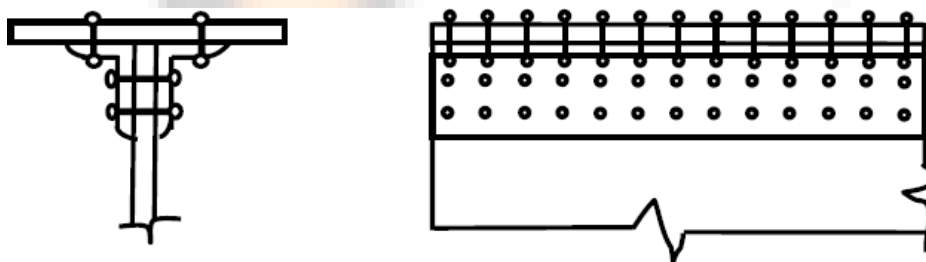

a) Riveted plate girder

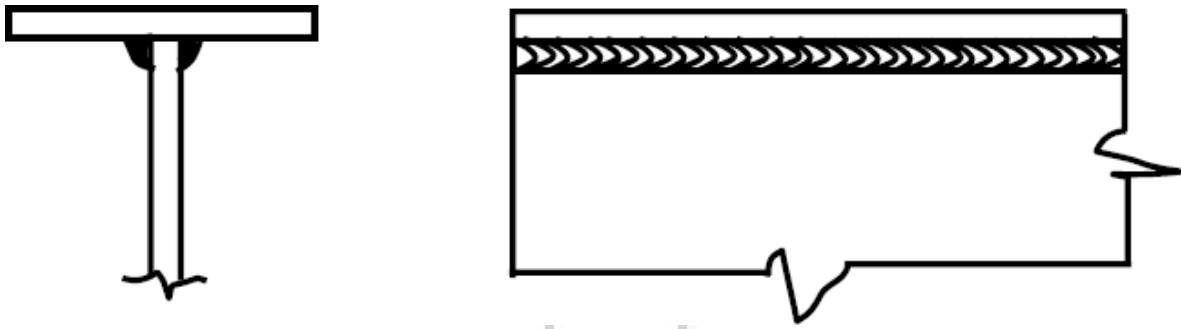

b). Welded plate girder

Figure 7.2

The range of application of welding is very wide. For example, connection of a steel pipe column to other members can be made very easily by welding whereas it is virtually impossible by bolting or riveting. Welding is practicable even for complicated shapes of joints.

- There is no need for holes in members connected by welding except possibly for erection purposes. This has direct influence in the case of tension members as the problem of determining the minimum net section is eliminated. This also results in a member with a smaller cross section.
 - Welded structures are more rigid compared to structures with riveted and bolted connections. The rigidity of welded structures is due to the direct connection of members by welding. In bolted or riveted structures, the connection is established through angles or plates, which deflect under loads, making the structure flexible.
 - It is easier to make design changes and to correct mistakes during erection, if welding is used. It is also a simple procedure to strengthen the existing structures with welding.
- *. A truly continuous structure is formed by the process of fusing the members together. This gives the appearance of a one-piece construction. Generally welded joints are as strong or stronger than the base metal, thereby placing no restriction on the joints.

Due to this continuity advantage, a very large number of steel frames have been constructed all over the world.

- Stress concentration effect is considerably less in a welded connection. Some of the lesser important advantages of the welding processes are: relative silence of the process of welding and fewer safety precautions.

Some of the disadvantages of welding are:

- Welding process requires highly skilled manpower
- Experienced manpower is needed for inspection of welded connections. Also, non-destructive evaluation may have to be carried out to detect defects in welds

- Welded joints are highly prone to cracking under fatigue loading
- Costly equipment is essential to make welded connections
- Proper welding can not be done in the field environment
- Large residual stresses and distortion are developed in welded connections

In the earlier days, combination of bolting, riveting and welding was not practiced. Structures were completely welded, bolted or riveted. Presently both are used in a structure except that both connection techniques are not used in one and the same joint. The present trend is to use welding for workshop connections or splices, and high strength bolts for field joints.

Basic welding processes

In general, gas and arc welding are employed; but, almost all structural welding is arc welding. In gas welding a mixture of oxygen and some suitable gas is burned at the tip of a torch held in the welder's hand or by an automatic machine. Acetylene is the gas used in structural welding and the process is called oxyacetylene welding. The flame produced can be used both for cutting and welding of metals. Gas welding is a simple and inexpensive process. But, the process is slow compared to other means of welding. It is generally used for repair and maintenance work. The most common welding processes, especially for structural steel, use electric energy as the heat source produced by the electric arc. In this process, the base metal and the welding rod are heated to the fusion temperature by an electric arc. The arc is a continuous spark formed when a large current at a low voltage is discharged between the electrode and the base metal through a thermally ionised gaseous column, called plasma. The resistance of the air or gas between the electrode and the objects being welded changes the electric energy into heat. A temperature of 33000 C to 55000 C is produced in the arc.

The welding rod is connected to one terminal of the current source and the object to be welded to the other. In arc welding, fusion takes place by the flow of material from the welding rod across the arc without pressure being applied.

Arc Welding Processes

Different processes of arc welding are explained in the following sections:

7.1.1 Shielded Metal Arc Welding (SMAW)

In Shielded Metal Arc Welding or SMAW (Fig. 7.3), heating is done by means of electric arc between a coated electrode and the material being joined. In case bare wire electrode (without coating) is employed, the molten metal gets exposed to atmosphere and combines chemically with oxygen and nitrogen forming defective welds. The electrode coating on the welding rod forms a gaseous shield that helps to exclude oxygen and stabilise the arc.

The coated electrode also deposits a slag in the molten metal, which because of its lesser density compared to the base metal, floats on the surface of the molten metal pool, shields it from atmosphere, and slows cooling. After cooling, the slag can be easily removed by hammering and wire brushing.

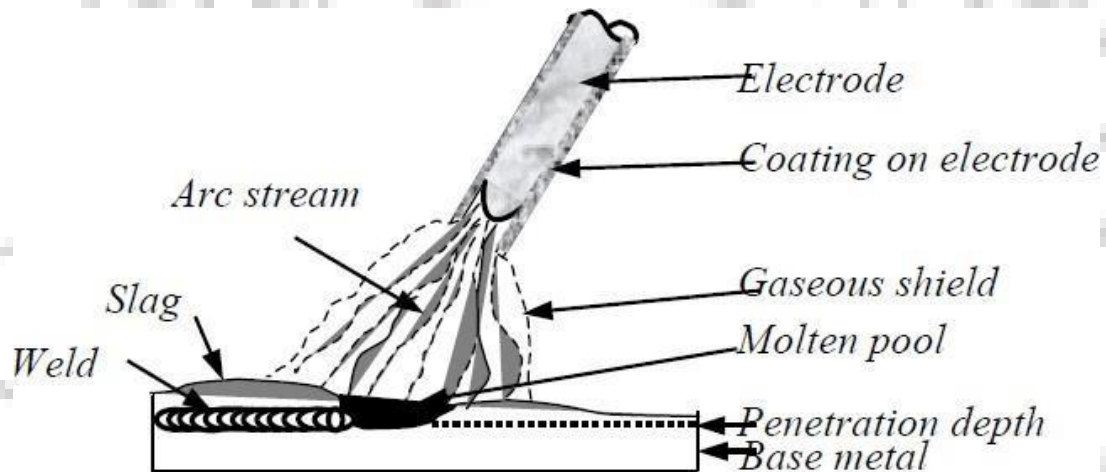

Figure 7.3 Shielded Metal Arc Welding (SMAW) process

The coating on the electrode thus

- Shields the arc from atmosphere
- Coats the molten metal pool against oxidation
- Stabilises the arc
- Shapes the molten metal by surface tension
- Provides alloying element to weld metal

The type of welding electrode used would decide the weld properties such as strength, ductility and corrosion resistance. The type to be used for a particular job depends upon the type of metal being welded, the amount of material to be added and the position of the work. The two general classes of electrodes are lightly coated and heavily coated. The heavily coated electrodes are normally used in structural welding. The resulting welds are stronger, more corrosion resistant and more ductile compared to welds produced by lightly coated electrodes. Usually the SMAW process is either automatic or semiautomatic.

Submerged Arc Welding (SAW)

In this arc welding process, the arc is not visible because it is covered by a blanket of fusible powdered flux. The bare metal electrode is deposited as a joining material. The flux, which is a special feature of the method, protects the weld pool against the atmosphere. The arc once started is at all times covered by the flux as shown in Fig. 7.4.

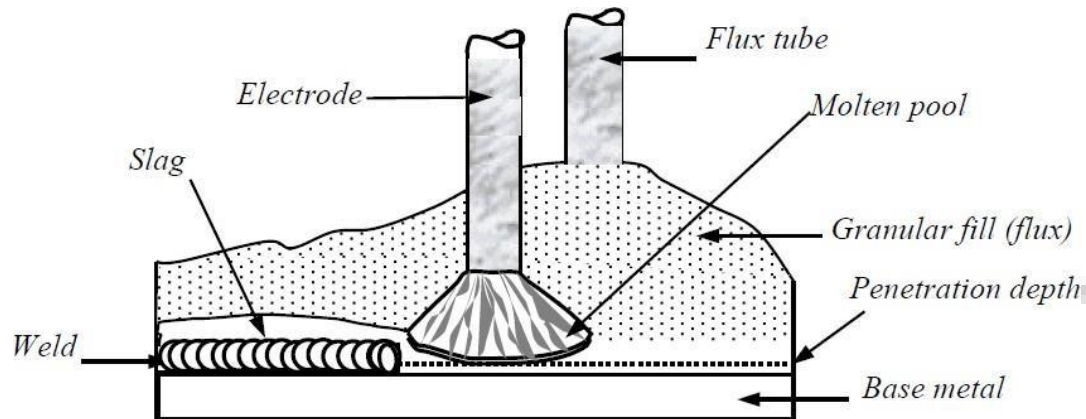

Figure 7.4 Submerged arc welding (SAW) process

The heat of the arc melts the electrode, the object to be welded, and part of the flux. The slag formed by the flux, which forms a coat over the solidified weld beam, may be removed by brushing. Welds made by submerged arc welding process have high quality, good ductility, high impact strength, high density and good corrosion - resistance. Their mechanical properties are as good as the base metal. Since more heat is input in this process, the penetration is deeper than the SMAW process. This is normally taken into account in the design.

Manual Metal Arc (MMA) Welding

This is a manually operated welding process and hence requires skill to produce good quality welds. The electrode is made up of a steel core wire (3.2 – 6.0 mm diameter) and the flux contains manganese and silicon as alloying elements. The electric arc melts the metallic object to be welded and the electrode. As the core wire metal melts and joins the weld pool, the electrode is moved to maintain the arc length. This is important as the arc length controls the width of the weld run. The flux also melts with steel core wire and forms the surface slag, which is removed after solidification.

Low capital cost and freedom of movement (up to 20 m from power supply) are the main advantages of MMA welding. It is well suited to structural and stainless steels. Its main disadvantage is that only a small volume of metal is deposited per electrode. This is not a problem for short welds, but for long welds this becomes a serious consideration.

Metal – Active Gas (MAG) welding

This is sometimes also referred to as Metal Inert Gas (MIG) welding. The arc and the weld pool are protected by an inert gas; the shielding gas often used is carbon dioxide or a mixture of oxygen and carbon dioxide. Flux is not necessary to shield the pool; however, occasionally a flux - cored electrode is used to produce slag. The arc length is maintained by the power supply unit. Though MAG welding is easier, more skill is required to establish the correct welding conditions. Using MAG welding, production is improved, as there is no need to deslag or change electrode. It is highly suitable for fillet - welded joints, such as beam to beam or stiffener to panel connections. Its disadvantage is due to restriction in movement due to equipment. This can be manual, semi-automatic or automatic process

Electroslag Welding Process

The method of Electroslag process (Fig. 7.5) used for vertical automatic welding is based on the heat produced by electrical current through molten slag. The electrode is immersed in the molten slag pool between the components to be welded and the copper moulding devices. As the melt is heated to a high temperature by current passing between the electrodes and the base metal, the electrical conductivity is increased. The slag pool temperature must exceed the melting points of the base and filler metals. Then the slag melts the faces of the connecting work and the electrode is immersed in the molten slag. The weld pool that forms when the molten base and filler metal collect at the bottom of the slag pool solidifies and forms the weld joining the faces of the members.

Electroslag welding is useful for joining thick sections in a vertical position. Single – pass welds can be made in any reasonable thickness of steel. Welding usually starts at the bottom of the joint and progresses towards the top of the vertical connection.

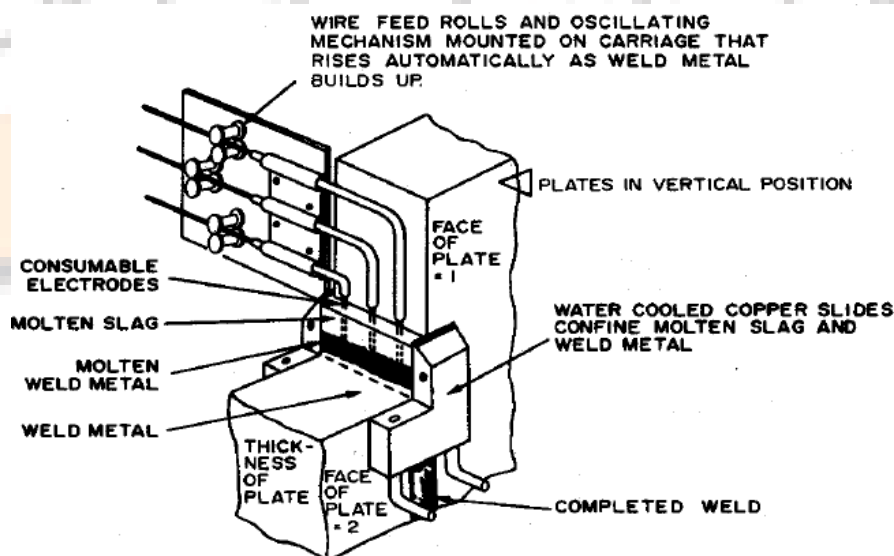

Figure 7.5 Electroslag welding process

Stud Welding

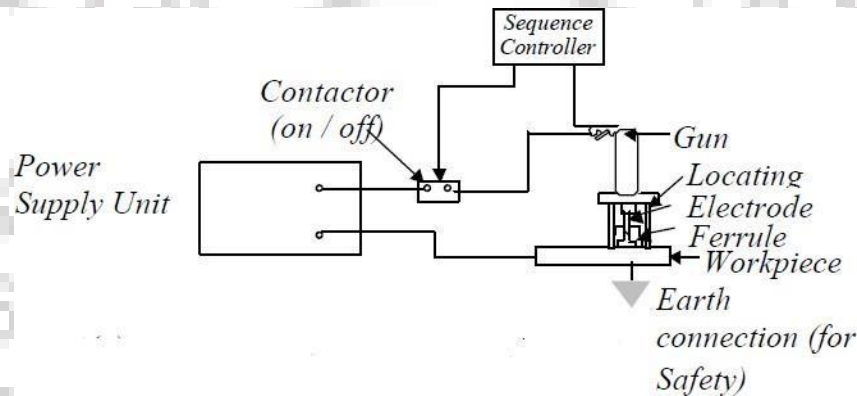

Figure 7.6 Stud Welding (Schematic Diagram)

This is an arc welding process and is extensively used for fixing stud shear connectors to beam in the composite construction. The equipment consists of gun hand tool (Fig. 7.6), D.C. power source, auxiliary contractor and controller. The stud is mounted into the chuck of the hand tool and conical tip of the stud is held in contact with the work piece by the pressure of a spring on the chuck. As soon as the current is switched on, the stud is moved away automatically to establish an arc. When a weld pool has been formed and the end of the stud is melted the latter is automatically forced into the steel plate and the current is switched off. The molten metal, which is expelled from the interface, is formed into a fillet by a ceramic collar or ferrule, which is placed around the stud at the beginning of the operation. The ferrule also provides sufficient protection against atmospheric contamination.

This process offers an accurate and fast method for attaching shear connectors, etc with the minimum distortion. While it requires some skill to set up the weld parameters (voltage, current, arc time and force), the operation of equipment is relatively straight forward.

Choice of Process

The choice of a particular process is made based on a number of parameters listed below:

- The location of the welding operation: In a protected place like a fabrication shop, SAW and MAG are best suited. For field conditions MMA is easier.
- Accuracy of setting up: SAW and MAG require good and accurate set-up.
- Penetration of the weld.
- Volume of weld to be deposited
- Access to joint: The welding plant and the welding torches have to be properly positioned during the welding operation. In easily accessible joints SAW or MAG is used, whereas in cramped locations MMA is preferred.
- Position of welding: SAW and MAG are not suitable for overhead positions. MMA is the best for overhead works.
- Steel composition: SAW and MAG do not generally develop HAZ (Heat Affected Zone) cracking. This offsets the disadvantage of MAG for site works.
- Comparative cost: cost of welding is calculated for unit length considering the duty cycles.

Welding procedure

The term 'welding procedure' encompasses the complete operation of making a weld. Thus, it includes choice of electrode, edge preparation, preheat, welding parameters such as voltage, current, welding position, number of weld run to fill the groove and post weld treatments (e.g. grinding, heat treatment etc.). Establishment of such procedures helps to the cost, achieve good impact properties, eliminates defects and controls distortion. Some of the important elements of weld procedure are elaborated below.

Environment: Weld procedure must account for actual site conditions. In cold regions, it may be necessary to heat steel up to 20%. The humid weather or condensation might help formation of porosity. Electrodes must be kept in dry condition. In moist / humid environments the electrodes may be kept in a warm container to avoid moisture entrapment in the flux coating.

Welding position: Vertical welding is slower compared to welding in the flat position. Overhead welding causes weld splutter and require special skills. It is better avoided.

Current: The current controls the heat input. A minimum current is required for fusing the plate and to keep the arc stable. Generally a high current is used to obtain quicker welding so as to reduce cost. It may not be possible to use maximum current always, a specific example being welding in the overhead position. The current limit for overhead use is 160A. Usually high current results in low impact properties. Further very high value of current may cause cracks in the Heat-Affected Zone (HAZ).

Shrinkage: While cooling after the welding operation, the hot metal in the welded region contracts causing the joint to shrink. But this contraction is prevented by the adjacent colder metal. This causes stress, sometimes even beyond yield stress, and causes plastic deformation. This also might cause distortion of the member. By following proper edge preparation and weld procedure, this can be minimised. After the plastic deformation a residual stress pattern is formed in the joint. Tensile stresses are formed in the weld metal and HAZ zones, whereas compression in the adjacent steel.

Pre heating: Hydrogen induced cracking (cold cracking, delayed cracking) is a serious problem affecting weldability. The degree of cracking occur due to the combined effects of four factors:

1. Brittle microstructure
2. Presence of hydrogen in weld metal
3. Tensile stresses in the weld area
4. Temperature range (-100o C to 200o C)

Pre heating of the weld area is the most effective and widely used method to prevent hydrogen induced cracking. Welding involves a cycle of sudden heating and cooling. By preheating the parent metal, the difference in temperature between the preheated temperature and the final temperature is reduced. This, in the cooling cycle, also helps to obtain a lower thermal gradient. Sudden cooling of steel results in a hard and less ductile material called martensite. The main function of preheating is to reduce the weld metal cooling rate so that transformation to martensite is reduced below a certain critical level. The slower cooling gives more time for hydrogen to diffuse out of the weld area and delays the development of maximum residual stresses. Gas torches, heat-treating furnaces or electric-resistance heaters are used in preheating the weld area.

Weldability of Steels

The term weldability is defined as the ability to obtain economic welds, which are good, crack - free and would meet all the requirements. Of great importance are the chemistry and the structure of the base metal and the weld metal. The effects of heating and cooling associated with fusion welding are experienced by the weld metal and the Heat Affected Zone (HAZ) of the base metal. The HAZ i.e. base metal surrounding the weld metal and the weld itself will have unduly varying hardness distribution across a weld. The hardness in steel depends upon the rate at which steel is cooled near the fusion zone; the hardness is maximum due to the higher temperature at that location. Further, these locations also have the maximum rate of cooling. Higher value of hardness leads to cracks in HAZ or in the weld. Cracks might be formed during or after the welding process.

Good design and standard welding procedure will minimise the cracking problem.

Several features that affect weld cracking during the welding processes are

- Joint restraint that builds up high stress in the weld

- Bead shape (convex or concave)
- Carbon and alloy content of the base metal
- Cooling rate
- Hydrogen and nitrogen absorption

The cracks in HAZ are mainly caused by high carbon content, hydrogen embrittlement and rate of cooling. For most steels, weld cracks become a problem as the thickness of the plates increases.

Types of joints and welds

By means of welding, it is possible to make continuous, load bearing joints between the members of a structure. A variety of joints is used in structural steel work and they can be classified into four basic configurations as shown in Figure 7.7.

They are:

1. Lap joint
2. Tee joint
3. Butt joint, and
4. Corner joint

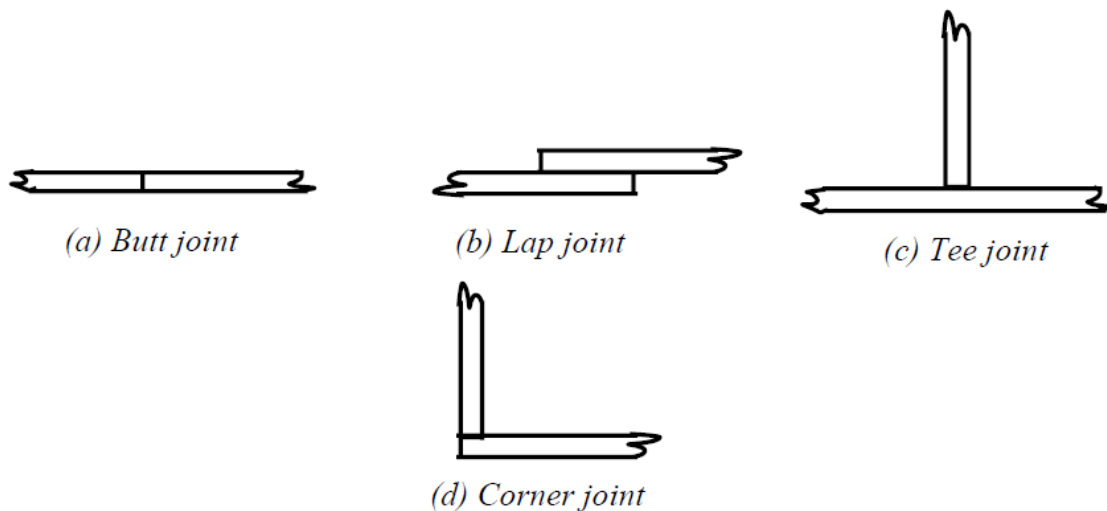

Figure 7.7 Types of joints

For lap joints the ends of two members are overlapped, and for butt joints the two members are placed end to end. The T- joints form a Tee and in Corner joints, the ends are joined like the letter L. The common types of welds are shown in Fig. 7. 8. Most common joints are made up of fillet weld and the groove weld. Plug and slot welds are not generally used in structural steel work. Fillet welds are suitable for lap joints and Tee joints and groove welds for butt and corner joints. Groove welds can be of complete penetration or incomplete penetration depending upon whether the penetration is complete through the thickness or partial.

Generally a description of welded joints requires an indication of the type of both the joint and the weld.

fillet welds are weaker than groove welds, about 80% of the connections are made with fillet welds. The reason for the wider use of fillet welds is that in the case of fillet welds, when members are lapped over each other, large tolerances are allowed in erection. For groove welds, the members to be connected have to fit perfectly when they are lined up for welding. Further groove welding requires the shaping of the surfaces to be joined as shown in Fig. 7.9. To ensure full penetration and a sound weld, a backup plate is temporarily provided as shown in Fig. 7.9.

Welds are also classified according to their position into flat, horizontal, vertical and overhead (Fig. 7.10). Flat welds are the most economical to make while overhead welds are the most difficult and expensive.

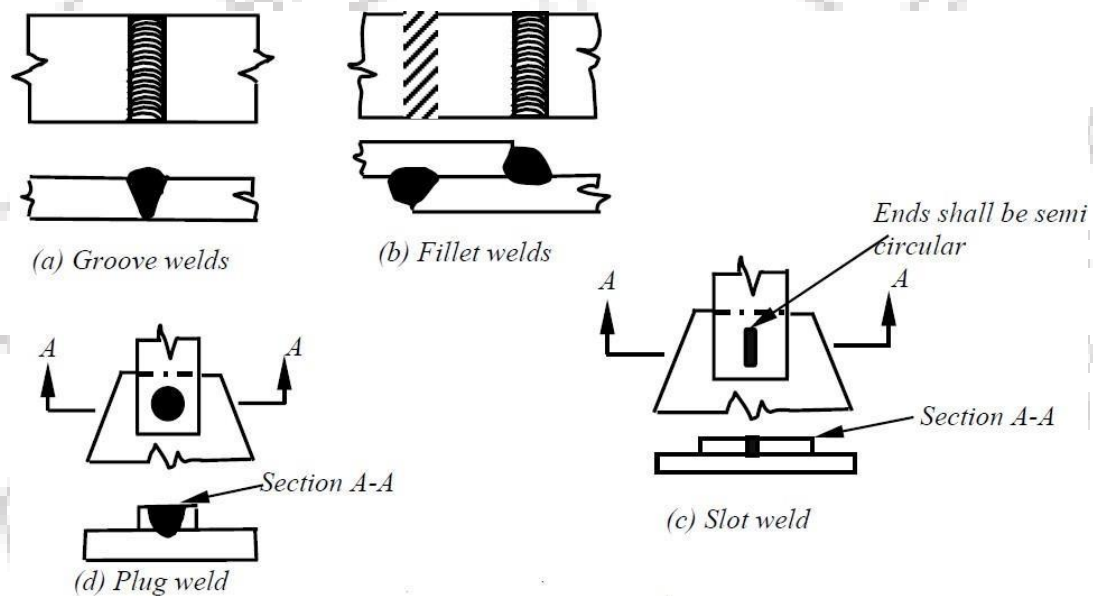

Figure 7.8 Common types of welds

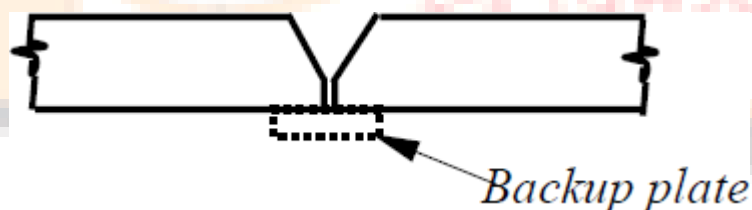

Figure 7.9 Shaping of surface and backup plate

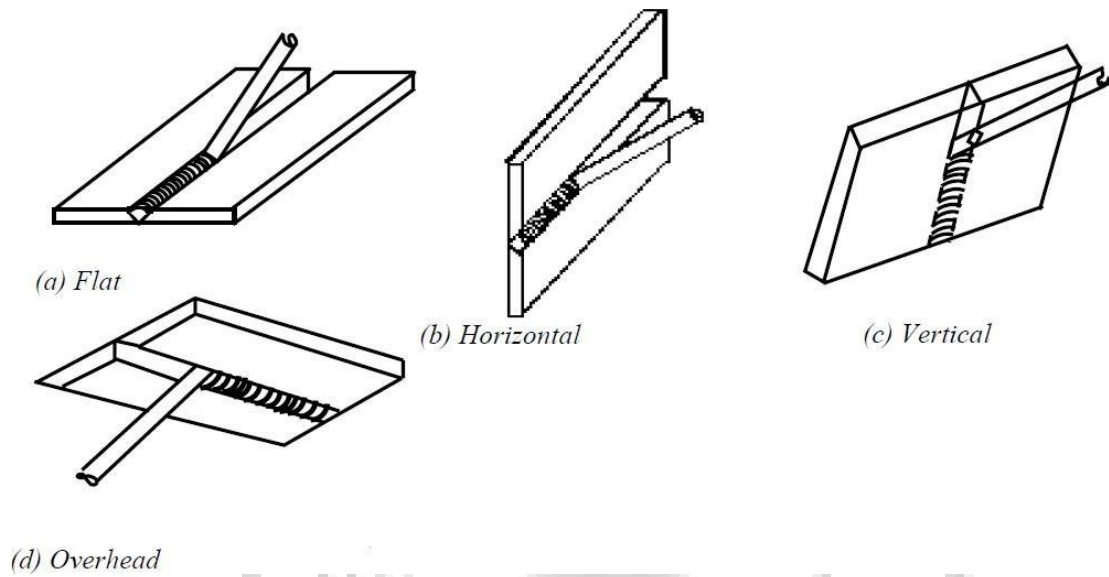

Figure 7.10 Classification based on position

Groove welds

The main use of groove welds is to connect structural members, which are in the same plane. A few of the many different groove welds are shown in Fig. 7.11. There are many variations of groove welds and each is classified according to its particular shape. Each type of groove weld requires a specific edge preparation and is named accordingly. The proper selection of a particular type depends upon

- Size of the plate to be joined.
- Welding is by hand or automatic.
- Type of welding equipment.
- Whether both sides are accessible.
- Position of the weld.

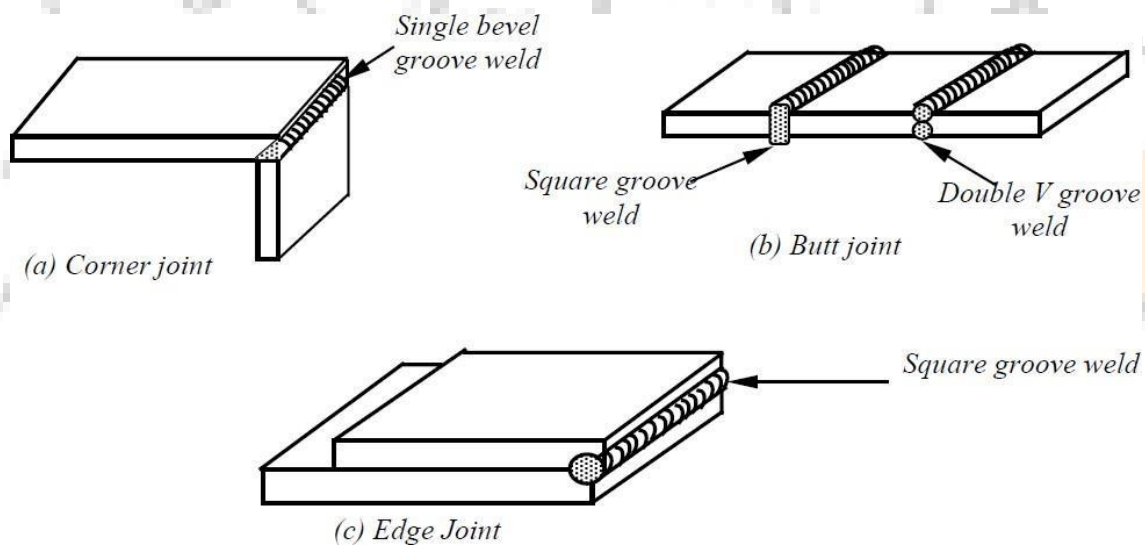

Figure 7.11 Typical connections with groove weld

The aim is to achieve the most economical weld of the requisite efficiency and strength. The butt weld whether of full penetration or partial penetration should attain the required strength of the joined parts. The size of the butt weld is defined by the thickness i.e. the thickness of the connected plate for complete penetration welds or the total depth of penetration for partial penetration welds.

Groove welds have high strength, high resistance to impact and cyclic stress. They are most direct joints and introduce least eccentricity in the joint. But their major disadvantages are: high residual stresses, necessity of edge preparation and proper aligning of the members in the field. Therefore, field butt joints are rarely used.

To minimise weld distortions and residual stresses, the heat input is minimised and hence the welding volume is minimised. This reduction in the volume of weld also reduces cost. Hence for thicker plates, double groove welds and U welds are generally used.

Edge Preparation for Butt Weld

Typical edge preparations are shown in Fig. 7.12

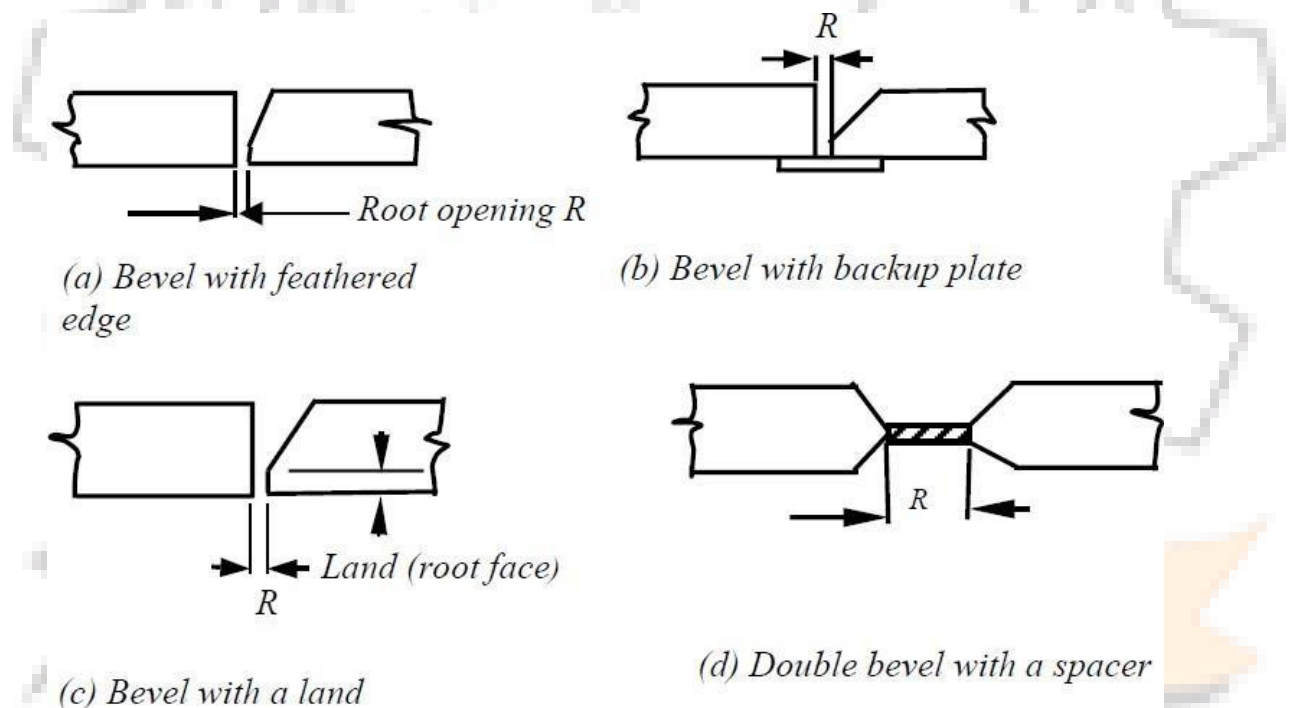

Figure 7.12 Typical edge preparation for butt weld

For a butt weld, the root opening, R , is the separation of the pieces being joined and is provided for the electrode to access the base of a joint. The smaller the root opening the greater the angle of the bevel. The depth by which the arc melts into the plate is called the depth of penetration [Fig. 7.13 (a)]. Roughly, the penetration is about 1 mm per 100A and in manual welding the current is usually 150 – 200 A.

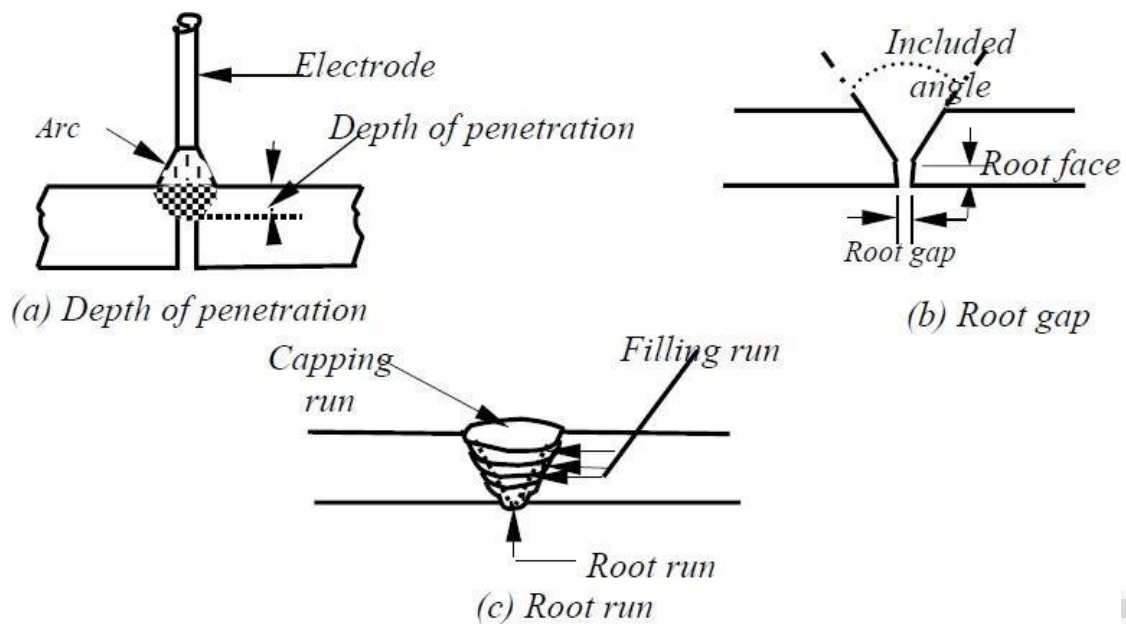

Figure 7.13 Groove weld details

Therefore, the mating edges of the plates must be cut back if through-thickness continuity is to be established. This groove is filled with the molten metal from the electrode. The first run that is deposited in the bottom of a groove is termed as the root run [Fig.13(c)]. For good penetration, the root faces must be melted. Simultaneously, the weld pool also must be controlled, preferably, by using a backing strip.

The choice of edge preparation depends on

1. Type of process
2. Position of welding
3. Access for arc and electrode
4. Volume of deposited weld metal
5. Cost of preparing edges
6. Shrinkage and distortion.

The square groove joint is used to connect thin material up to about 8 mm thick; for thicker material, single-vee groove and the double-vee groove welds have to be used.

Fillet welds

A typical fillet weld is shown in Fig. 7.14 (a).

Weld and leg size

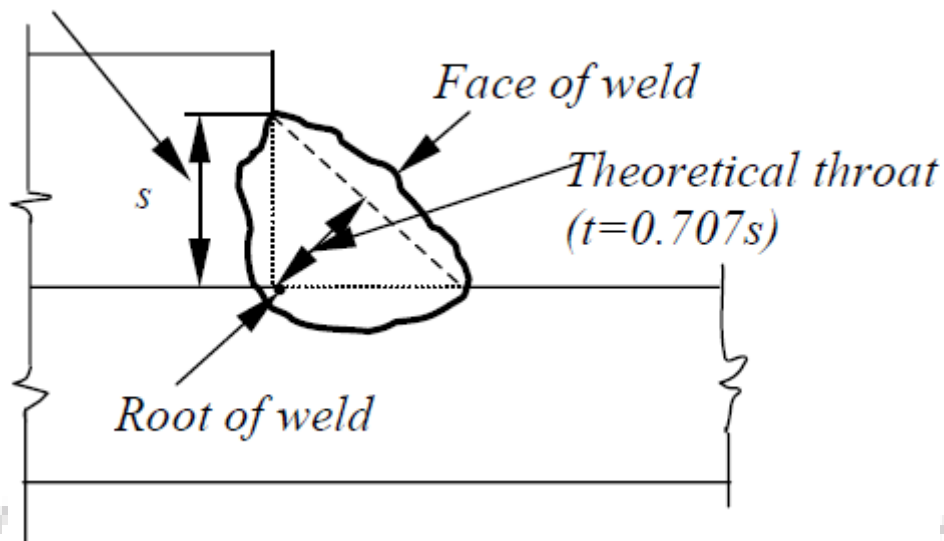

Figure 7.14 Typical fillet weld

Owing to their economy, ease of fabrication and adaptability, fillet welds are widely used. They require less precision in the fitting up because the plates being joined can be moved about more than the groove welds. Another advantage of fillet welds is that special preparation of edges, as required by groove welds, is not required. In a fillet weld the stress condition in the weld is quite different from that of the connected parts.

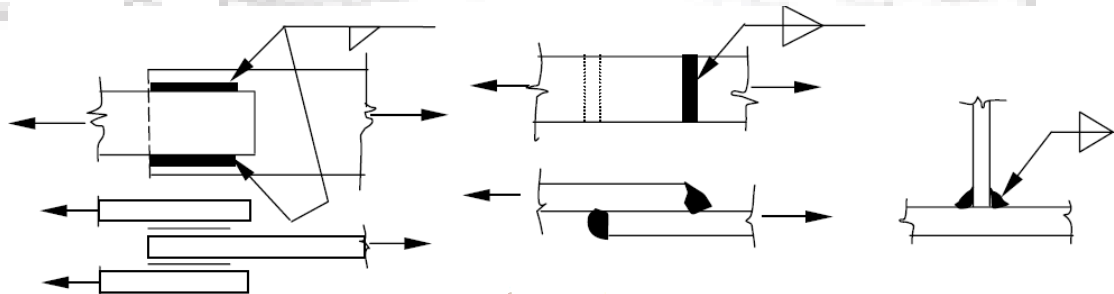

Figure 7.15 Typical fillet weld connections

The size of a fillet weld is defined by the length of the two sides of the largest right triangle, which can be inscribed within the weld cross section. A major share of welds of this type has equal legs i.e. they form right isosceles triangle shown in Fig. 7.15(c). The typical fillet weld connections are shown in Fig. 7.15(b). The critical dimension of a fillet weld is its throat, the shortest distance from the root to the hypotenuse of the defining triangle shown in Fig. 7.15(c). Also Unequal and Equal legs fillet welds are shown in Figure 7.16.

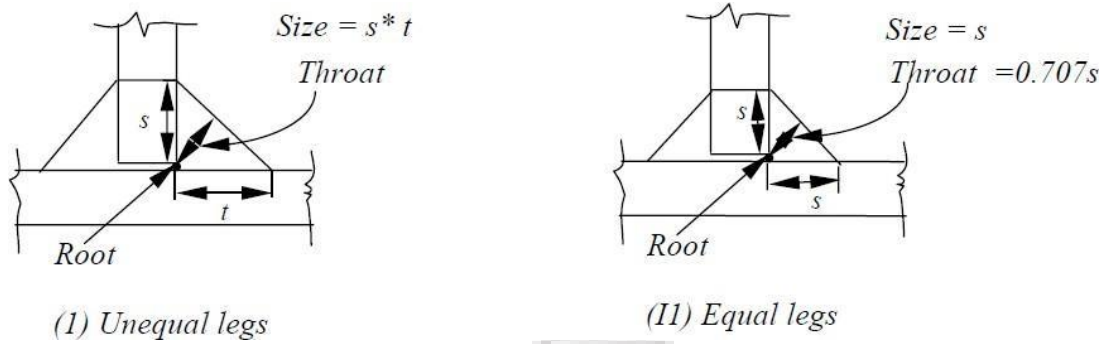

Figure 7.16 Unequal and Equal legs fillet welds

The root of the weld is the point where the faces of the metallic members meet. The theoretical throat of a weld is the shortest distance from the root to the hypotenuse of the triangle. The throat area equals the theoretical throat distance times the length of the weld. Though a fillet weld is specified by defining the two sides of the inscribed triangle, its actual cross section will be quite complex. A fillet weld must penetrate the base metal and the interface of the weld is either concave or convex [Fig. 7.17(a)&(b)].

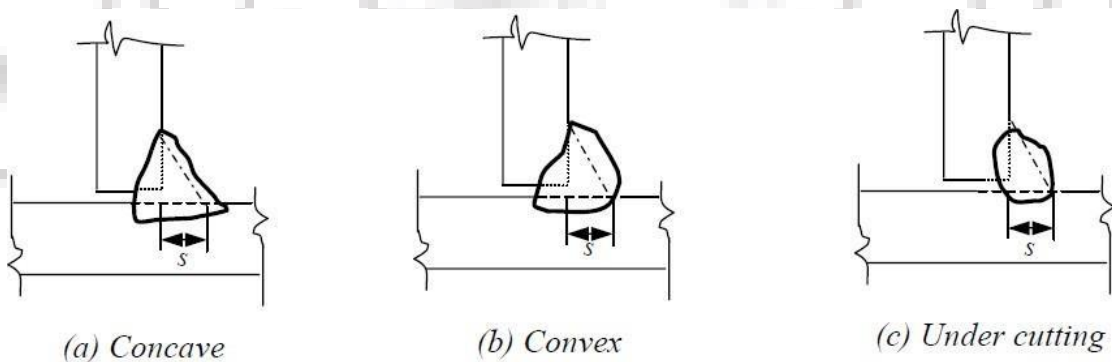

Figure 7.17 Cross section of fillet weld

The concave shape of free surface provides a smoother transition between the connected parts and hence causes less stress concentration than a convex surface. But it is more vulnerable to shrinkage and cracking than the convex surface and has a much reduced throat area to transfer stresses. On the other hand, convex shapes provide extra weld metal or reinforcement for the throat. But while making a convex surface there is always the possibility of causing undercut at the edges, which undermines the strength of the joint [Fig. 7.17(c)]. The stress concentration is higher in convex welds than in concave welds. It is generally recommended that for statically loaded structures, a slightly convex shape is preferable, while for fatigue – prone structures, concave surface is desirable. Large welds are invariably made up of a number of layers or passes. For reasons of economy, it is desirable to choose weld sizes that can be made in a single pass. Large welds can be made in a single pass by an automatic machine, though manually, 8 mm fillet is the largest single-pass layer.

Weld symbols

Welding will become a powerful engineering tool when the information required for welding is provided by the designers to the operators. The information concerning type, size, position, welding process etc. of the welds in welded joints is conveyed by standard symbols in drawings. Usage of standard symbols by all designers and fabricators would help avoid confusion and misunderstanding. The symbolic representation gives clearly all necessary indications regarding the specific weld to be achieved.

The symbolic representation includes elementary symbols along with a) supplementary symbol, b) a means of showing dimensions, or c) some complementary indications. IS: 813-1986, "Scheme Of Symbols for Welding" gives all the details of weld representation in drawings.

Elementary symbols represent the various categories of the weld and look similar to the shape of the weld to be made. Combination of elementary symbols may also be used, when required. Elementary symbols are shown in Table 7.1.

Supplementary symbols characterise the external surface of the weld and they complete the elementary symbols. Supplementary symbols are shown in Table 7.2. Combinations of elementary and supplementary symbols are given in Table 7.3. The weld locations are defined by specifying, a) position of the arrow line, b) position of the reference line, and c) the position of the symbol. More details of weld representation may be obtained from IS 813-1986.

Defects in welds

If good welding methods and procedures are not followed a number of defects may be developed causing discontinuities within the weld. Some of the important defects are described in the following.

Incomplete fusion

Complete fusion may not take place, if the mating surfaces are not properly cleaned of all coatings such as mill scales, slag, oxides etc. This defect may also be caused by insufficient current, because of which the base metal does not melt properly. Rapid rate of welding also leads to improper fusion. The different types of incomplete fusion are shown in Fig.7.18.

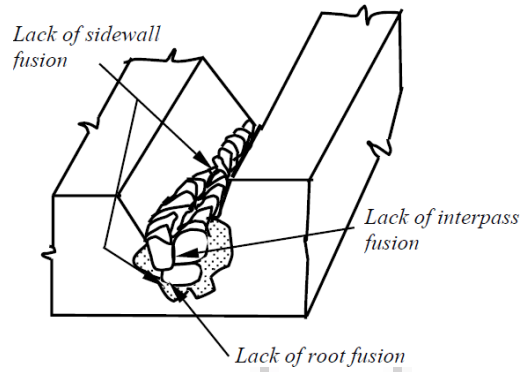
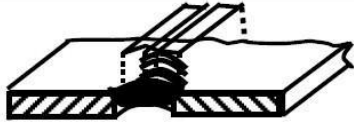











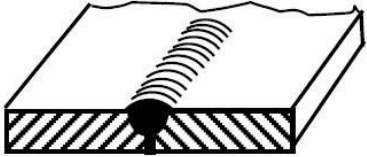
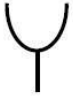

Figure 7.18 Lack of fusion (or) incomplete fusion

Table 7.1 Elementary Symbols

Illustration(Fig.)	Symbol	Description
		Butt weld between plates with raised edges*(the raised edges being melted down completely)
		Square butt weld
		Single-V butt weld
		Single-bevel butt weld
		Single – V butt weld with broad root face
		Single – bevel butt weld with broad root face
		Single – U butt weld (parallel or sloping sides)







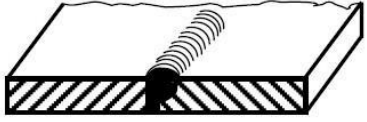

		Single – J butt joint
		Backing run; back or backing weld
		Fillet weld
		Plug weld; plug or slot weld
		Spot weld

Table 7. 2 Supplementary Symbols



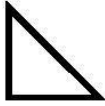
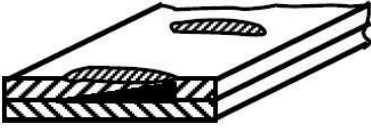

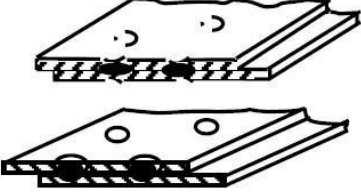
		Seam weld
---	---	-----------

Table 7. 3 Combination of Elementary and Supplementary Symbols

Shape Of Weld Surface	symbol
(a) flat (usually finished flush)	
(b) convex	
(c) concave	

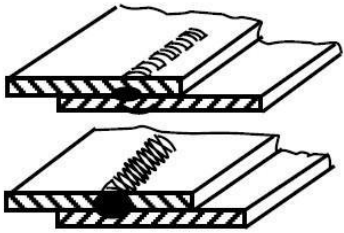
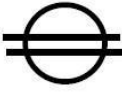
Porosity

Porosity is formed when a number of gas pockets or voids are trapped during the cooling process. Use of excessively high current and longer arc length are the reasons for this type of defect. Porosity may occur in two ways: Either dispersed through the weld or as a large pocket at the root near to the backup plate in a groove weld. Improper welding procedures and careless use of backup plates result in porosity in groove welds.

Inadequate penetration

In certain instances, partial penetration may be adequate. However when the weld penetration is less than that specified, it is termed as inadequate penetration. This type of defect, primarily occurring in groove welds, is due to insufficient groove angles, very large electrodes, inadequate weld current, larger welding rates, or insufficient gaps at the root of welds. The defect can be avoided by means of backup plates. Inadequate penetration is shown in Fig.7.19.

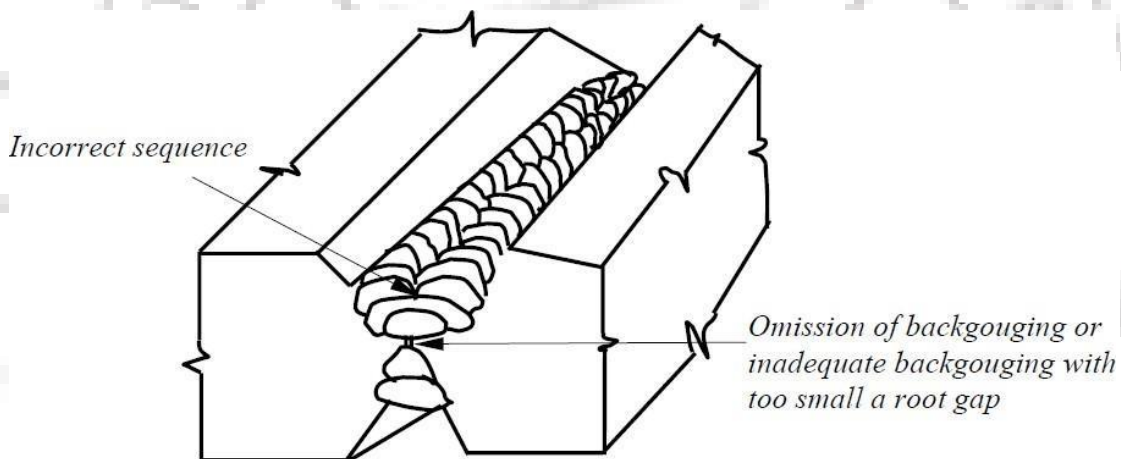

Figure 7.19 Lack of penetration

Under cutting

This type of defect is formed due to the use of excessive current or an excessively long arc. A portion of the metal is burnt away reducing the thickness of the joint at the edge of the weld. The defect is detected easily by visual inspection and repaired easily by depositing additional weld material. Examples of under cutting are shown in Fig. 7.20.

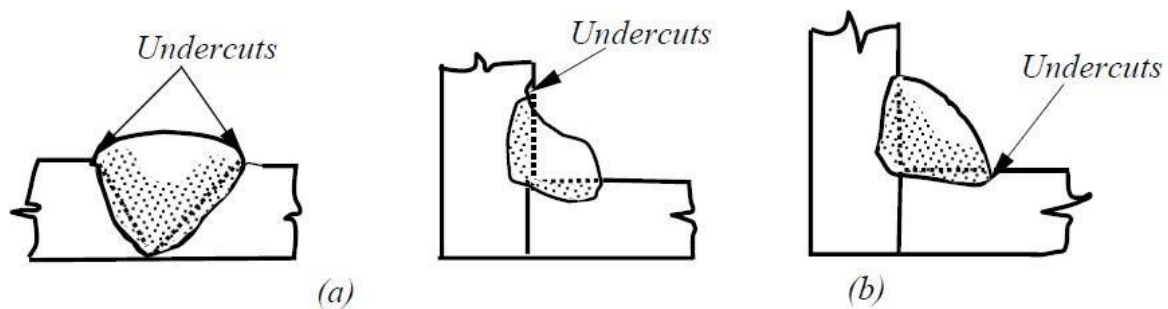

Figure 7.20 Typical examples of undercut defect. (a) Wide and curved, (b) Narrow and crack like

Slag inclusion

Slag is formed in the welding process due to the chemical reaction of the melted electrode coating. It normally consists of metal oxides and other compounds. Since it has less density than the molten weld metal the slag usually floats on the surface. On cooling, this is removed by the welder. But, if the cooling is rapid, the slag may get trapped before it can rise to the surface. When several passes of weld are made to achieve the desired weld size, the slag that forms between each process must be removed completely. The main reason for slag inclusion is due to the failure to remove the slag fully between runs. Overhead welds are also susceptible to slag inclusion and hence adequate care should be taken. Slag inclusion is shown in Fig. 7.21.

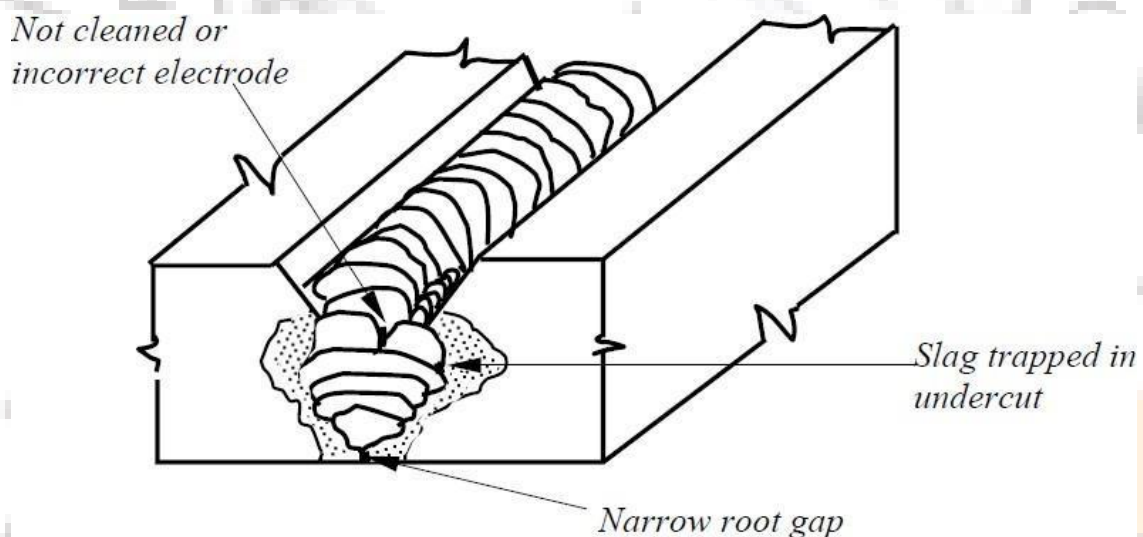

Figure 7.21 Slag inclusion

Cracks

Cracks are by far the most severe form of weld defects. Cracks occur in the form of breaks in the weld metal. They are the result of internal stresses and form either longitudinally or

transversely to the line of weld. Cracks may extend from the welded metal into the base metal. They may also be completely in the base metal very near to the weld in HAZ.

Cracks may occur either in the hot or cold form. Hot cracks are formed as the weld begins to solidify. Uniform heating and slower cooling will prevent hot cracks. Cold cracks, which occur at room temperature, run parallel to but under the weld in the base metal. Using certain special electrodes and proper preheating and post heating, cold cracking can be reduced.

Lamellar Tearing

Lamellar tearing is a type of cracking that occurs in the base metal beneath the weld. It is caused by the combined effects of high, localised stresses from weld contraction and poor through - thickness ductility in the steel. The tearing is started by the separation of the interface between inclusions and metal (also known as delamination) or by fracture of an inclusion itself. The cracks grow by the joining of the delamination in the same plane or by the shear steps, which join the cracks in different planes. This results in a characteristic step-like appearance for lamellar tearing. Lamellar tear is shown in Fig. 7.22.

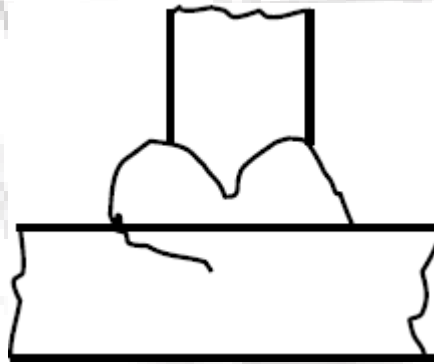

Figure 7.22 Lamellar tear

The influencing factors in lamellar tearing are:

- Amount of Non-metallic inclusion and their orientation.
- Magnitude of induced normal stresses normal to the plate surface.

The presence of inclusions reduces the ductility of steel in the through – thickness direction because the bond between the inclusion and steel is much weaker than steel itself. The magnitude of stresses induced depends on the joint design, the imposed degree of restraint on the joint, plate thickness, size of the weld and orientation of the weld. Restrained corner or T-joints are most susceptible to lamellar tearing, as the through - thickness contraction stresses are high. Butt welds rarely experience lamellar tear. Thick plate, high restraint (rigid clamping) and large weld beads all contribute to residual stresses and the chances of tearing. Hydrogen also increases the vulnerability to lamellar tearing. Hence preheat is beneficial to reduce the tendency to lamellar tearing. It is also beneficial to use low hydrogen consumables.

The following precautions may be taken to reduce lamellar tearing.

- Using plate material with improved through – thickness properties.
- Designing the joint with minimum through-thickness stresses.
- Using lower strength welding consumables.
- In special cases, the plate may be ground to a level below where lamellar tearing is expected. The area can be provided with weld metal and the attachment weld can be made.

Weld defect acceptance levels

Weld defects acceptance levels are closely related to the available methods of Non - Destructive Examination (NDE).

Previously, radiography was the best technique available for inspection of welds. Then, acceptance conditions were in terms of maximum slag inclusion and porosity levels. Presence of cracks was not acceptable and repairs were absolutely essential. The use of ultrasonic technique has made it possible to detect smaller cracks, when compared to radiography. Thus, welds, which passed radiographic inspection, required extensive repair by the new method of inspection. The method of fracture mechanics has made it possible to assess the potential of cracks to cause serious damage and thus to come up with tolerable defect sizes. Slag inclusion and porosity may not be particularly deleterious defects unless fatigue type of loading is anticipated. By fracture mechanics approach, it has been established that the cracks detected by the ultrasonic methods are far smaller than those that affect the safety of the structure. Uses of fracture mechanics method has proved that tolerable defect sizes are large. This would result in cost saving in terms of repair and reduce the level of NDE inspection.

Accepted Criteria for Welded Joints

In general the following weld defects detected during inspection are acceptable for structures.

- For joints welded from both the sides, incomplete penetration with thickness up to 5% of the parent metal thickness, but not exceeding 2 mm and the length more than 500 mm can be accepted. The aggregate length of flaw shall not be more than 200 mm per meter length of the joint. Incomplete penetration and cracks are not allowed at or near the end or beginning of a joint.
- For joints welded from one side without backing strip, incomplete penetration with thickness up to 15% of parent metal thickness but not exceeding 3 mm at the root is allowed.
- Slag inclusion located along the weld as a chain or unbroken line is allowed if their aggregate length does not exceed 200 mm per meter of weld length. Size of the slag may also be considered.
- Total of isolated gas pores and slag inclusion shall not exceed 5 in number per square centimetre of the weld.
- Total of incomplete penetration, slag inclusion on pores located separately or as a

chain shall not exceed 10% of metal thickness but not greater than 2 mm when welding is done from both the sides and 15% of metal thickness, but not greater than 3 mm when welding is done from one side.

*.For metal thickness up to 10 mm, undercuts shall not be more than 0.5 mm. For metal thickness more than 10 mm, undercuts shall not be greater than 1 mm.

Incomplete weld, molten metal flow, pits and cracks shall not be allowed.

Welding inspection

There are essentially three steps to be followed to ensure good welding; they are:

- 1 Establishing good welding procedures
- 2 Use of pre-qualified welders
- 3 Availability of competent inspectors in shop and field

It is essential that welded joints are thoroughly examined and defects are detected so that any possible distress could be averted. There are several non-destructive testing methods to check the quality of welds. They are explained in the following.

Visual inspection

Visual inspection by a competent person will give a good indication of the quality of welds; but may not be able to gauge the sub surface condition of the welds. An experienced welder, by visual inspection, would be able to know whether satisfactory fusion and penetration are obtained. He will be able to recognise good welds by their shape, size and general appearance. In a good weld, the metal should be nearly its original colour after it has cooled. In case of over heating, it will give a rusty appearance. There are several scales and gauges to check the size and shape of welds. Methods of determining the internal soundness of a weld are described in the following section.

Liquid Penetrants

In this method, a type of dye is spread over the weld surface. This dye penetrates into the surface cracks of the weld. After the penetration of the dye, any excess material is removed and a powdery developer is sprayed to draw the dye out of the cracks. Then, the outline of the cracks can be seen with naked eye. In some cases, fluorescent dyes are used for improved visibility of the cracks.

Magnetic Particles

The weld that is inspected is 'magnetised' electrically. Cracks, which are present at or near the surface, would cause North and South poles to form on each side of the cracks. Dry iron filings are then kept on the weld. They form patterns when they cling to cracks. From the patterns, the location of cracks, their size and shapes are established.

Ultrasonic Testing

By means of the ultrasonic equipment, sound waves are sent through one side of the material and they are reflected from the opposite side. These reflections are indicated in a cathode ray tube. Any defect in the weld will alter the time of the sound transmission. By the help of the picture in the tube, flaws can be detected and their severity can be judged.

Radiography

This is an expensive method and can be used to check the welds in important structures. Portable X-ray machines along with radium or radioactive cobalt would give excellent pictures. This method is reliable for butt welds, but is not satisfactory for fillet welds due to difficulty in interpreting pictures. Another drawback of the method is the radioactive danger. Much care has to be taken while carrying out this inspection to protect the workers on the job.

A properly welded connection is usually much stronger (1.5 to 2 times) than the strength of the members being connected. The reasons for the extra strength are: electrode wire is made up of premium steel, the metal is melted electrically and the cooling rate is rapid. Due to these factors, the weld strength is always higher than required by the design.

The following figure 7.22 illustrates the identification of good and bad welds and Figure 7.23 shows the unacceptable weld profiles.

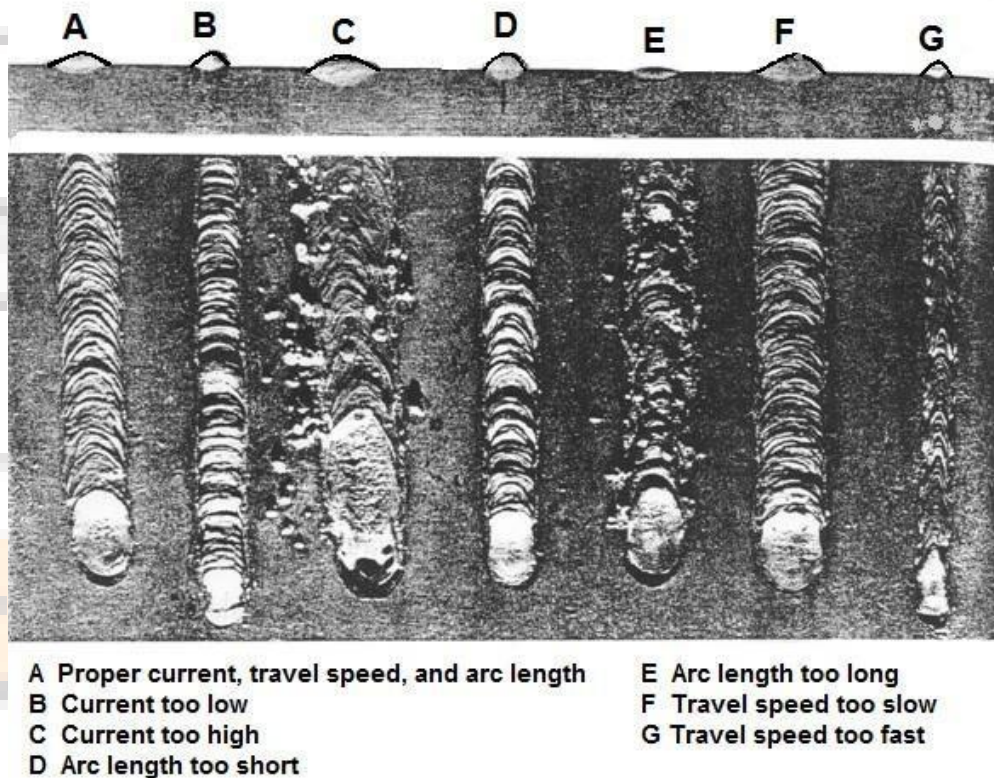

Figure 7.22 Identifying good and bad welds



Figure 7.23 unacceptable weld profiles





Welded Connections

Introduction

In this Lecture, the behaviour and design of welded connections under various static loading conditions is considered.

It is well known that welded connections are continuous and more rigid when compared to bolted connections. It is also seen that fillet welds and butt welds constitute respectively 80% and 15% of all welds in the construction industry; the balance 5% is made up by plug, slot and spot resistance welds.

Connection design

In the design of connections, due attention must be paid to the flow of the force through the connection. The transfer of forces should occur smoothly, without causing any stress concentration or cracks. The connections can be either concentric or eccentric. In concentric connections, the forces acting on the connections will essentially be axial in nature, whereas in eccentric connections, the axial forces will be coupled with bending or torsion. These types of connections are described in the following.

Concentric connections

Static strength of a welded joint depends upon the following factors

- Type and size of the weld
- Manner of welding, and
- Type of electrode used.

A primary responsibility of a designer is to select the type and size of the weld. A number of varieties of welds are available. When it is properly chosen with the correct electrode, it develops full strength of the parent material. The chosen type of weld should develop minimal residual stresses and distortions.

Generally, butt and fillet welds are the usual forms of welds in practical building construction. Butt welds are used at an edge-to-edge junction or a tee junction. A butt weld connection is made by bringing the plates to be joined face to face edgewise and then filling the cavity formed by edge preparation or by just penetrating the unprepared junction. Butt welds can be either full penetration or partial penetration.

Partial penetration butt welds may be used for static loading, if reduced strength is acceptable. On the other hand, a fillet weld is made away from the edges of the abutting plates. The joint is formed by welding the members in an overlapped position or by using a secondary joining material. The main advantage of a fillet weld is that the requirements of alignment and tolerance are less rigorous when compared to butt welds. Fillet welding could be applied for lap joints, tee joints and corner joints. A detailed description of these two types of welds and their design requirements are presented in the following.

Butt welds

Full penetration butt welds are formed when the parts are connected together within the thickness of the parent metal. For thin parts, it is possible to achieve full penetration of the weld. For thicker parts, edge preparation may have to be done to achieve the welding, which has been discussed in the previous lecture.

There are nine different types of butt joints: square, single V, double V, single U, double U, single J, double J, single bevel and double bevel. They are shown in Fig. 8.1. In order to

qualify for a full penetration weld, there are certain conditions to be satisfied while making the welds. The more important ones are given below:

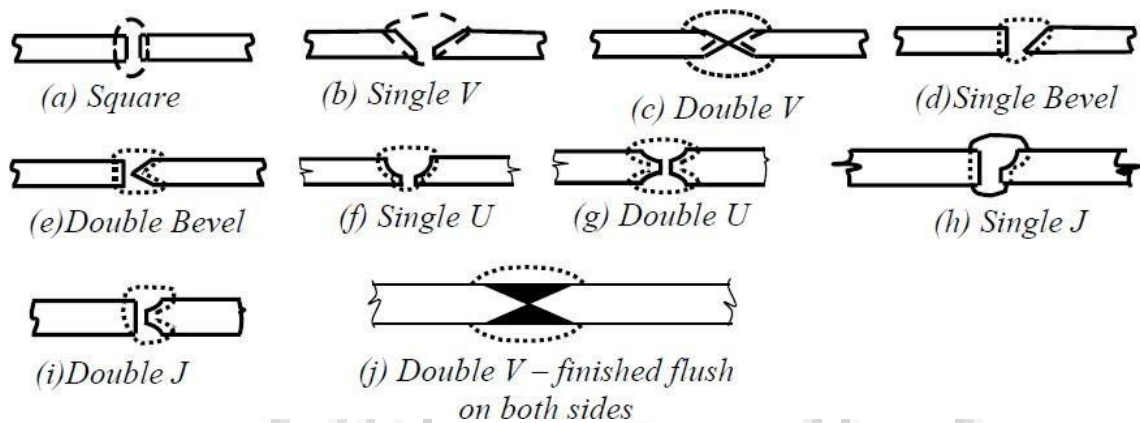

Figure 8.1 Different types of butt joints

Static behaviour of butt welds

For butt welds the most critical form of loading is tension applied in the transverse direction (Fig. 8.2). It has been observed from tests conducted on tensile coupons containing a full penetration butt weld normal to the applied load that the welded joint had higher strength than the parent metal itself. During the application of the load, the welded portion and the HAZ (Heat Affected Zone of the parent metal) have less transverse contraction compared to the parent metal. The yield stress of the weld metal and the parent metal in the HAZ region was found to be much higher than the parent metal. The increase in yield stress in the HAZ is due to the quenching effect associated with rapid cooling after deposition of the weld.

The yield stress of the weld metal is also raised due to the quenching effect. The metal alloys constituting the electrode contribute to the increase in yield stress. These alloys penetrate the parent metal influencing its mechanical properties.

Due to the lower yield stress and higher transverse contraction in the parent metal, it experiences a higher true stress. As a consequence, the failure of the coupon always occurs away from the weld. The higher strength achieved by the welded joint adversely affects its toughness and ductility properties. These negative effects can be minimised by choosing proper electrodes.

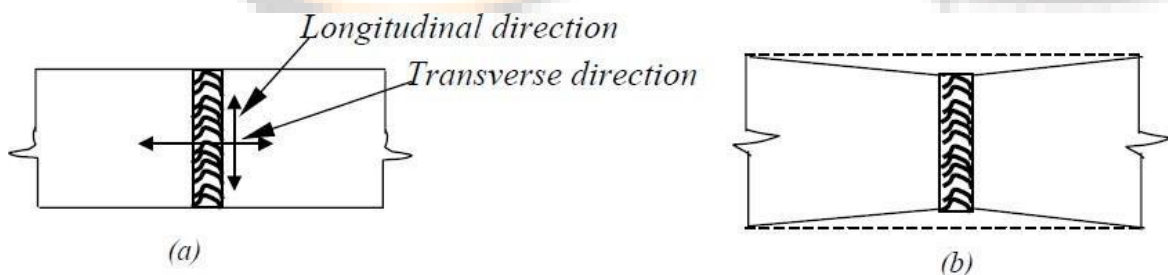

Figure 8.2 (a) Load applied in transverse direction (b) longitudinal shrinkage restraint

Partial penetration welds, shown in Fig. 8. 3, differ in two ways from the full penetration welds: the reduction in cross section and the uncertainty of the weld root quality. Firstly, there is a reduction in the cross section at the joint resulting in overloading and severe plastic straining. Further, the weld root quality cannot be inspected and they cannot be repaired as may be done for full penetration welds.

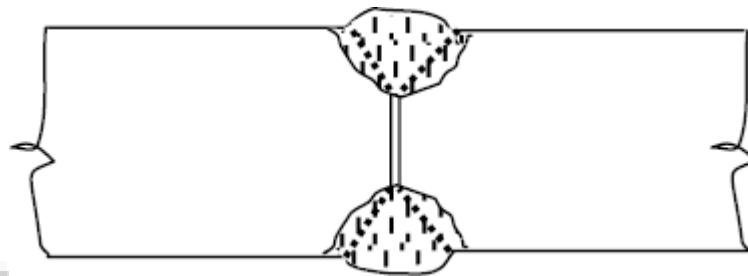

Figure 8.3 Partial penetration weld

Design

The butt weld is normally designed for direct tension or compression. However, a provision is made to protect it from shear. Design strength value is often taken the same as the parent metal strength. For design purposes, the effective area of the butt-welded connection is taken as the effective length of the weld times the throat size. Effective length of the butt weld is taken as the length of the continuous full size weld. The throat size is specified by the effective throat thickness. For a full penetration butt weld, the throat dimension is usually assumed as the thickness of the thinner part of the connection. Even though a butt weld may be reinforced on both sides to ensure full cross-sectional areas, its effect is neglected while estimating the throat dimensions. Such reinforcements often have a negative effect, producing stress concentration, especially under cyclic loads.

Generally speaking, partial penetration welds must be avoided. Partial penetration groove welds are used in non-critical details, so as to avoid back-gouging. If they are considered essential, they should be designed with care. Some codes of practice do not recommend their use in tension. Others specify that they be designed in the same way as fillet welds. This is because the load transfer is not smooth and efficient with partial penetration welds. The effective throat thickness of a partial penetration weld is taken as the minimum thickness of the weld metal common to the parts joined, excluding reinforcement. For stress calculation, a maximum value of reduced effective throat thickness equal to $\frac{5}{8}$ of the thickness of the thinner part joined must be used. The unwelded portion in partial penetration butt welds, welded from both sides, shall not be greater than $\frac{1}{4}$ thickness of the thinner part joined, and should be in the central portion.

If the stresses are uniform across the throat thickness, the average stress concept may be applied to determine its strength. Connections with partial penetration welds with welding on

only one side is generally avoided under tensile load due to the eccentric loading involved. Otherwise, the eccentricity effects should be considered in the design.

Unsealed butt welds of V, U, J and bevel types and incomplete penetration butt welds should not be used for highly stressed joints and joints subjected to dynamic and alternating loads. Intermittent butt welds are used to resist shear only and the effective length should not be less than four times the longitudinal space between the effective length of welds nor more than 16 times the thinner part. They are not to be used in locations subjected to dynamic or alternating stresses. Some modern codes do not allow intermittent welds in bridge structures.

For butt welding parts with unequal cross sections, say unequal width, or thickness, the dimensions of the wider or thicker part should be reduced at the butt joint to those of the smaller part. This is applicable in cases where the difference in thickness exceeds 25 % of the thickness of the thinner part or 3.0 mm, whichever is greater. The slope provided at the joint for the thicker part should not be steeper than one in five [Figs. 8.4 (a) &(b)]. In instances, where this is not practicable, the weld metal is built up at the junction equal to a thickness which is at least 25 % greater than the thinner part or equal to the dimension of the thicker part [Fig.8. 4(c)]. Where reduction of the wider part is not possible, the ends of the weld shall be returned to ensure full throat thickness.

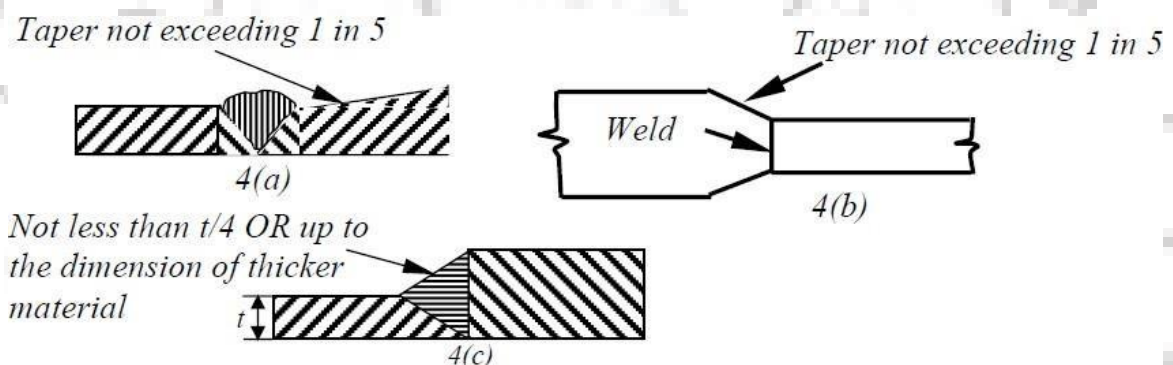

Figure 8.4 Butt welding of members with (a)&(b) unequal thickness (c) unequal width

Permissible stresses for butt welds are assumed same as for the parent metal with a thickness equal to the throat thickness. For field welds, the permissible stresses in shear and tension may be reduced to 80% of the above value.

Effective length of Groove welds

The effective length of groove welds in butt joints is taken as the length of continuous full size weld, but it should not be less than four times the size of the weld.

Effective area of groove weld (Figure 8.5)

The effective area of groove weld is the product of the effective throat dimension t_e multiplied by the effective length of the weld. The effective throat dimension of a groove weld depends on the minimum width of expected failure plane

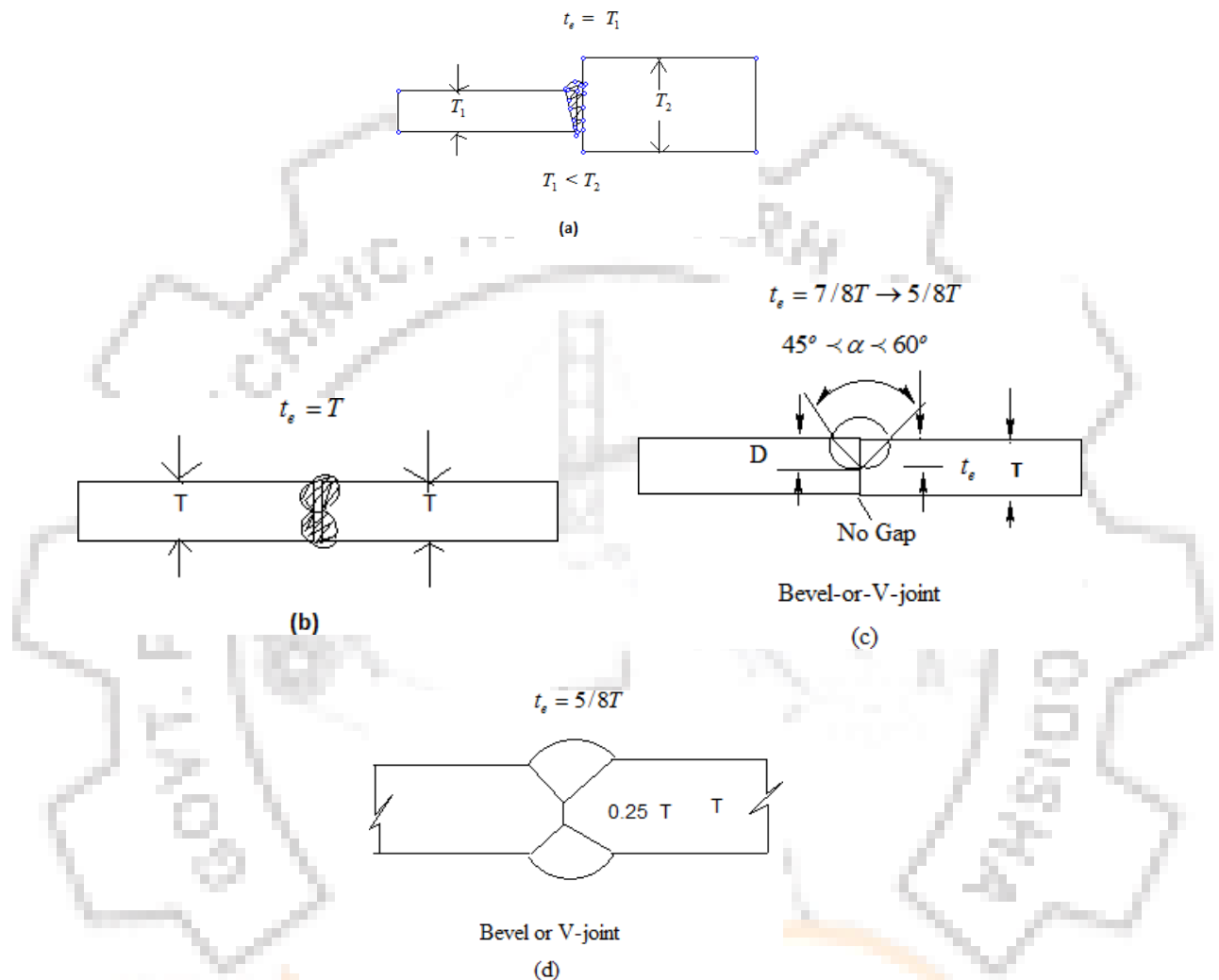

Figure 8.5 Effective throat dimensions for groove welds

The effective throat thickness of a complete penetration groove weld is taken as the thickness of the thinner part joined. The effective throat thickness of T or L joints are taken as the thickness of the abutting part. Reinforcement which is provided to ensure full cross-sectional area is not considered as part of the effective throat thickness.

The effective throat thickness of partial penetration joint weld is taken as the minimum thickness of the weld metal common to the parts joined, excluding reinforcement. In unsealed single groove welds of V, U, J and bevel types and groove welds welded from one side only, the throat thickness should be at least $7/8^{\text{th}}$ of the thickness of the thinner part joined. However, for the purpose of stress calculation, the effective throat thickness of $5/8^{\text{th}}$ thickness of the thinner member only should be used (IS816:1969). The unwelded portion in

incomplete penetration welds welded from both sides should not be greater than 0.25 times the thickness of the thinner part joined and should be central in the depth of the weld. In this case also, a reduced effective throat thickness of $5/8^{\text{th}}$ of the thickness of the thinner part should only be used in the calculations. Groove welds used in butt joints, where the penetration is less than those specified above, due to non-accessibility, should be considered as non-load carrying for the purposes of design calculations.

Design of Butt Welds as per IS 800: 2007

The following assumptions are usually made in the analysis of welded joints

- The welds connecting the various parts are homogeneous, isotropic and elastic
- The parts connected by the welds are rigid and their deformation is therefore neglected
- Only stresses due to external forces are considered. The effects of residual stresses, stress concentrations and shape of the weld are neglected.

As per IS 800: 2007 the grooved welds in butt joints will be treated as parent metal with a thickness equal to the throat thickness and the stresses shall not exceed those permitted in the parent metal.

- For tension or compression normal to effective area and tension and compression parallel to the axis of the weld,

$$T_{dw} = \frac{f_y L_w t_e}{\gamma_{mw}}$$

Where T_{dw} is the design strength of the weld in tension, f_y is the smaller of yield stress of the weld and the parent metal in MPa, t_w is the effective throat thickness of the weld in mm, L_w is the effective length of the weld in mm, and γ_{mw} is the partial safety factor taken as 1.25 for shop welding and as 1.5 for site welding.

- For shear on effective area

$$V_{dw} = \frac{L_w t_e f_{yw}}{\sqrt{3} \gamma_{mw}}$$

Where V_{dw} is the design strength of the weld in shear.

As discussed previously, in the case of complete penetration groove weld in butt joints, design calculations are not required as the weld strength of the joint is equal to or even greater than the strength of the member connected. In the case of incomplete penetration groove weld in butt joints, the effective throat thickness is computed and the required effective length is determined and checked whether the strength of the weld is equal to or greater than the strength of the member connected to the applied external force.

Problem 1: Two plates of thickness 14 mm and 12 mm are to be jointed by a groove weld as shown in Figure 8.6 below.

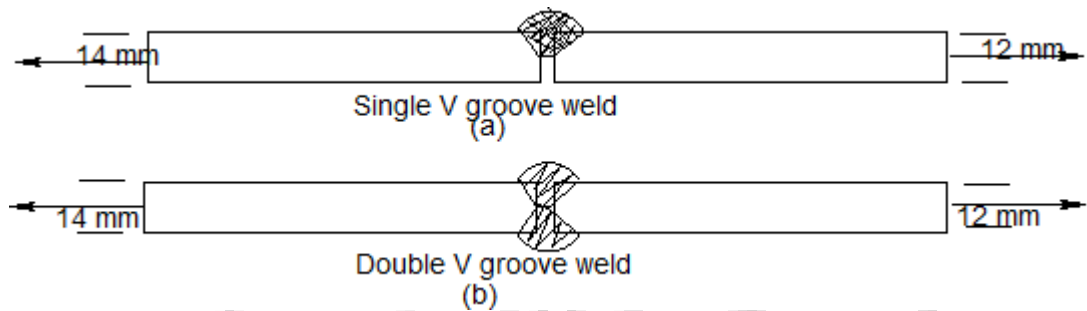

Figure 8.6

The joints are subjected to a factored tensile force of 350 kN. Assuming an effective length of 150 mm, check the safety of the joint for i) single V-groove weld joint ii) double V-groove weld joint

Assume that Fe410 grade steel plates are used and that the welds are shop welded.

Solution

Case (i)

Single V-groove weld: In this case, incomplete penetration results due to single-V groove weld

Hence throat thickness,

$$t_e = 5t / 8 = 5 \times 12 / 8 = 7.5 \text{ mm}$$

Effective length of weld $L_e = 150 \text{ mm}$

$$\text{Strength of weld} = L_e t_e f_y / \gamma_{mw} = 7.5 \times 150 \times 250 / (1.25 \times 1000) = 225 \text{ kN} < 350 \text{ kN}$$

Hence the joint is not safe

Case (ii)

In the case of double-V groove weld, complete penetration takes place

Throat thickness = thickness of thinner plate = 12 mm

$$\text{Strength of weld} = 12 \times 150 \times 250 / (1.25 \times 1000) = 360 \text{ kN} > 350 \text{ kN} \text{ hence the joint is safe.}$$

Case (i)

Sample Matlab Program is provided for calculating strength of butt weld (incomplete penetration)

```
% Calculation of the strength of the weld
% t = thickness of the plate
% te=5/8t (for incomplete penetration)
%te=t (for complete penetration)
% Le= effective length of the weld
% fy=yield strength of the plate
% vmw= partial safety factor for weld material
```

```

t=12;
te=5*t/8;
Le=150;
fy=250;
vmw=1.25;
P=Le*te*fy/vmw
% P in KN
P=P/1000

```

Case (ii)

Sample Matlab Program is provided for calculating strength of butt weld (complete penetration)

```

% Calculation of the strength of the weld
% t = thickness of the plate
% te=5/8t (for incomplete penetration)
%te=t (for complete penetration)
% Le= effective length of the weld
% fy=yield strength of the plate
% vmw= partial safety factor for weld material

```

```

t=12;
te=1*t/1;
Le=150;
fy=250;
vmw=1.25;
P=Le*te*fy/vmw
% P in KN
P=P/1000

```

Problem 2 : The tie member of a truss is made of ISA 65 x 65 x 6 mm is subjected to a factored tension load of 90 KN. The length of the angle is not enough to go from end to end and hence a splice has to be provided. Design a groove welded joint.

Solution:

Provide a single V groove weld

The effective throat thickness = $t_e = 5t / 8 = 5 \times 6 / 8 = 3.75 \text{ mm}$

Perimeter length of angle available for welding = $65 + 65 = 130 \text{ mm}$

Strength of weld = $L_e t_e f_y / \gamma_{mw} = 3.75 \times 130 \times 250 / (1.25 \times 1000) = 97.5 \text{ KN} > 90 \text{ KN}$

Area of angle = 744 mm^2

Design strength of the member = $A f_y / \gamma_{mo} = 744 \times 250 / (1.1 \times 1000) = 169 \text{ KN} > 90 \text{ KN}$

Fillet welds

These are generally used for making lap joint splices and other connections where the connecting parts lap over each other. Though a fillet weld may be subjected to direct stresses, it is weaker in shear and therefore the latter is the main design consideration.

Fillet welds are broadly classified into side fillets and end fillets (Fig. 8.7). When a connection with end fillet is loaded in tension, the weld develops high strength and the stress

developed in the weld is equal to the value of the weld metal. But the ductility is minimal. On the other hand, when a specimen with side weld is loaded, the load axis is parallel to the weld axis. The weld is subjected to shear and the weld shear strength is limited to just about half the weld metal tensile strength. But ductility is considerably improved. For intermediate weld positions, the value of strength and ductility show intermediate values.

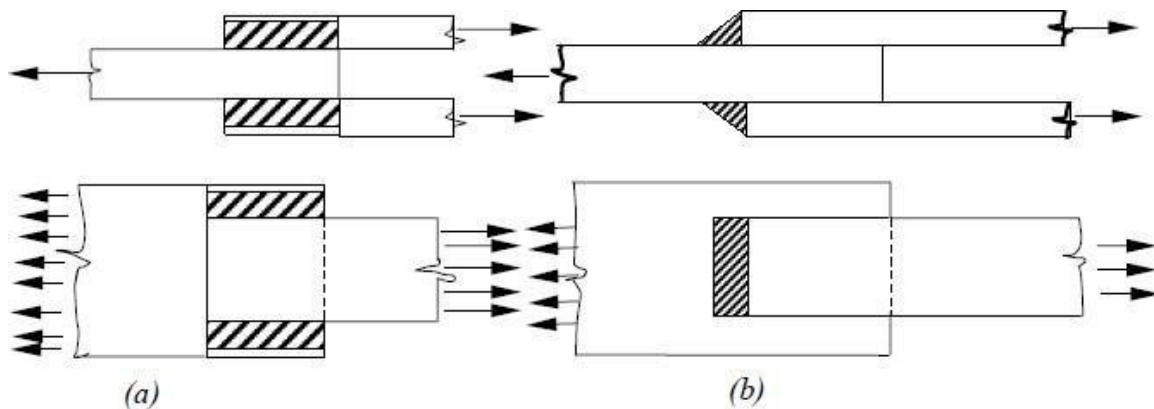

Figure 8.7 Fillet (a) side welds and (b) end welds

Actual distribution of stresses in a fillet weld is very complex. A rigorous analysis of weld behaviour has not been possible so far. Multiaxial stress state, variation in yield stress, residual stresses and strain hardening effects are some of the factors, which complicate the analysis.

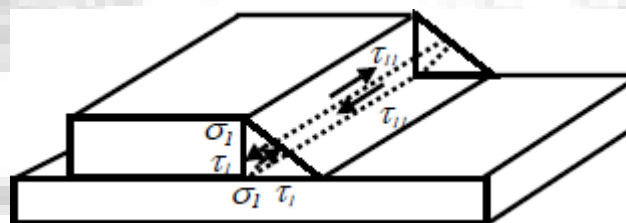

Figure 8.8 Average stress in the weld throat

In many cases, it is possible to use the simplified approach of average stresses in the weld throat (Fig. 8.8). In order to apply this method, it is important to establish equilibrium with the applied load. Studies conducted on fillet welds have shown that the fillet weld shape is very important for end fillet welds. For equal leg lengths, making the direction of applied tension nearly parallel to the throat leads to a large reduction in strength. The optimum weld shape recommended is to provide shear leg equal to 3 times the tension leg. A small variation in the side fillet connections has negligible effect on strength. In general, fillet welds are stronger in compression than in tension.

Design

A simple approach to design is to assume uniform fillet weld strength in all directions and to specify a certain throat stress value. The average throat thickness is obtained by dividing the applied loads summed up in vectorial form per unit length by the throat size. Alternatively,

design strength can be different with direction of the load vector. This method is limited in usage to cases of pure shear, tension or compression (Fig.8.9). It cannot be used in cases where the load vector direction varies around weld group. For the simple method, the stress is taken as the vector sum of the force components acting in the weld divided by the throat area.

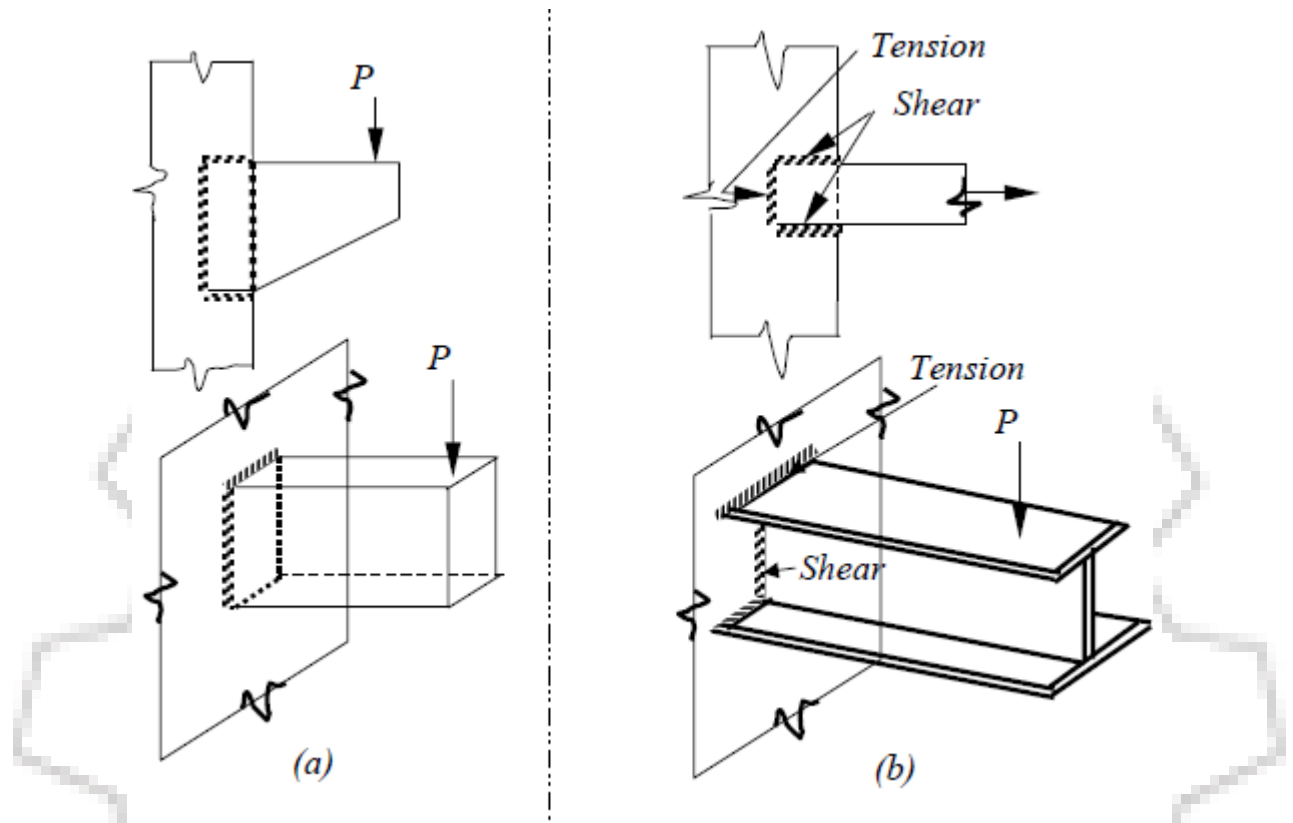

Figure 8.9 (a) connections with simple weld design,(b) connections with direction- dependent weld design

The size of a normal fillet should be taken as the minimum leg size (Fig. 8.10).

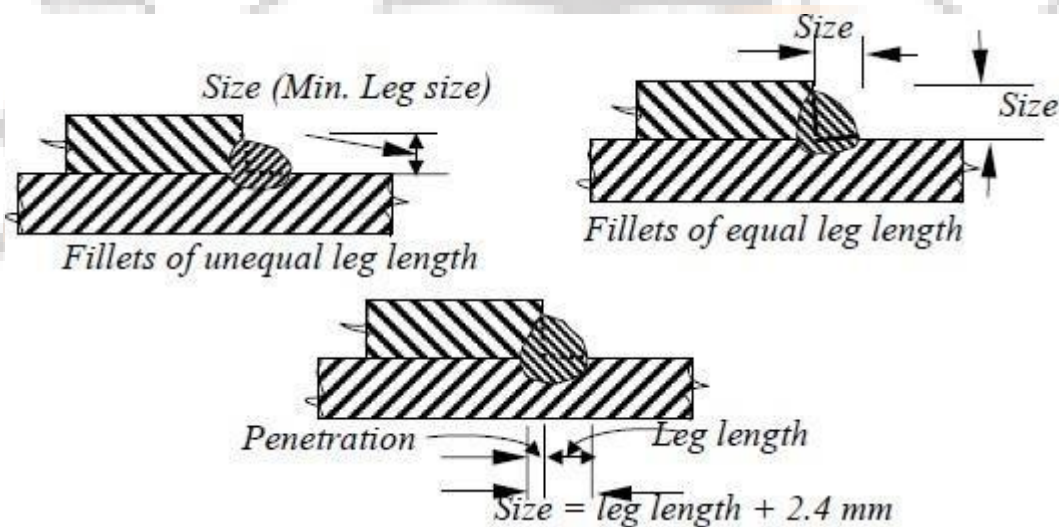

Figure 8.10 Sizes of fillet welds

For a deep penetration weld, the depth of penetration should be a minimum of 2.4 mm. Then the size of the weld is minimum leg length plus 2.4 mm. The size of a fillet weld should not be less than 3 mm or more than the thickness of the thinner part joined. Minimum size requirement of fillet welds is given below in Table 8.1. Effective throat thickness should not be less than 3 mm and should not exceed 0.7 t and 1.0 t under special circumstances, where 't' is the thickness of thinner part.

Table 8.1 Minimum size of first run or of a single run fillet weld

(Clause 10.5.2.3)

Sl No.	Thickness of Thicker Part mm		Minimum Size mm
	Over	Up to and Including	
(1)	(2)	(3)	(4)
i)	–	10	3
ii)	10	20	5
iii)	20	32	6
iv)	32	50	8 of first run 10 for minimum size of weld

NOTES

1 When the minimum size of the fillet weld given in the table is greater than the thickness of the thinner part, the minimum size of the weld should be equal to the thickness of the thinner part. The thicker part shall be adequately preheated to prevent cracking of the weld.

2 Where the thicker part is more than 50 mm thick, special precautions like pre-heating should be taken.

For stress calculations, the effective throat thickness should be taken as K times fillet size, where K is a constant. Values of K for different angles between tension fusion faces are given in Table 8.2. Fillet welds are normally used for connecting parts whose fusion faces form angles between 60° and 120°. The actual length is taken as the length having the effective length plus twice the weld size. Minimum effective length should not be less than four times the weld size. When a fillet weld is provided to square edge of a part, the weld size should be at least 1.5 mm less than the edge thickness [Fig. 8.11(a)]. For the rounded toe of a rolled section, the weld size should not exceed 3/4 thickness of the section at the toe [Fig. 8.11(b)].

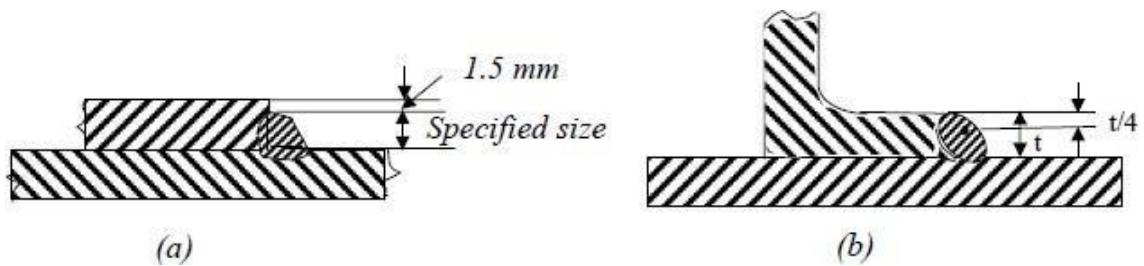

Figure 8.11 (a) fillet welds on square edge of plate, (b) fillet welds on round toe of rolled section

Table 8.2 Value of K for different angles between fusion faces

(Clause 10.5.3.2)

Angle Between Fusion Faces	60°-90°	91°-100°	101°-106°	107°-113°	114°-120°
Constant, K	0.70	0.65	0.60	0.55	0.50

Intermittent fillet welds may be provided where the strength required is less than that can be developed by a continuous fillet weld of the smallest allowable size for the parts joined. The length of intermediate welds should not be less than 4 times the weld size with a minimum of 40 mm. The clear spacing between the effective lengths of the intermittent welds should be less than or equal to 12 times the thickness of the thinner member in compression and 16 times in tension; in no case the length should exceed 20 cm. Chain intermittent welding is better than staggered intermittent welding. Intermittent fillet welds are not used in main members exposed to weather. For lap joints, the overlap should not be less than five times the thickness of the thinner part. For fillet welds to be used in slots and holes, the dimension of the slot or hole should comply with the following limits:

- The width or diameter should not be less than three times the thickness or 25 mm whichever is greater
- Corners at the enclosed ends or slots should be rounded with a radius not less than 1.5 times the thickness or 12 mm whichever is greater, and
- The distance between the edge of the part and the edge of the slot or hole, or between adjacent slots or holes, should be not less than twice the thickness and not less than 25 mm for the holes.

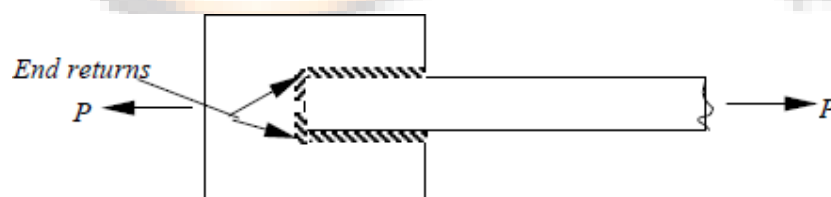

Figure 8.12 End returns

The effective area of a plug weld is assumed as the nominal area of the whole in the plane of the faying surface. Plug welds are not designed to carry stresses. If two or more of the general types of weld (butt, fillet, plug or slots) are combined in a single joint, the effective capacity of each has to be calculated separately with reference to the axis of the group to determine the capacity of the welds.

The high stress concentration at ends of welds is minimised by providing welds around the ends as shown in Fig. 8.12. These are called end returns. Most designers neglect end returns in the effective length calculation of the weld. End returns are invariably provided for welded joints that are subject to eccentricity, impact or stress reversals. The end returns are provided for a distance not less than twice the size of the weld.

Slot Welds

In certain instances, the lengths available for the normal longitudinal fillet welds may not be sufficient to resist the loads. In such a situation, the required strength may be built up by welding along the back of the channel at the edge of the plate if sufficient space is available. This is shown in Fig. 8.13(a). Another way of developing the required strength is by providing slot or plug welds. Slot and plug welds [Fig. 8.13(b)] are generally used along with fillet welds in lap joints. On certain occasions, plug welds are used to fill the holes that are temporarily made for erection bolts for beam and column connections. However, their strength may not be considered in the overall strength of the joint.

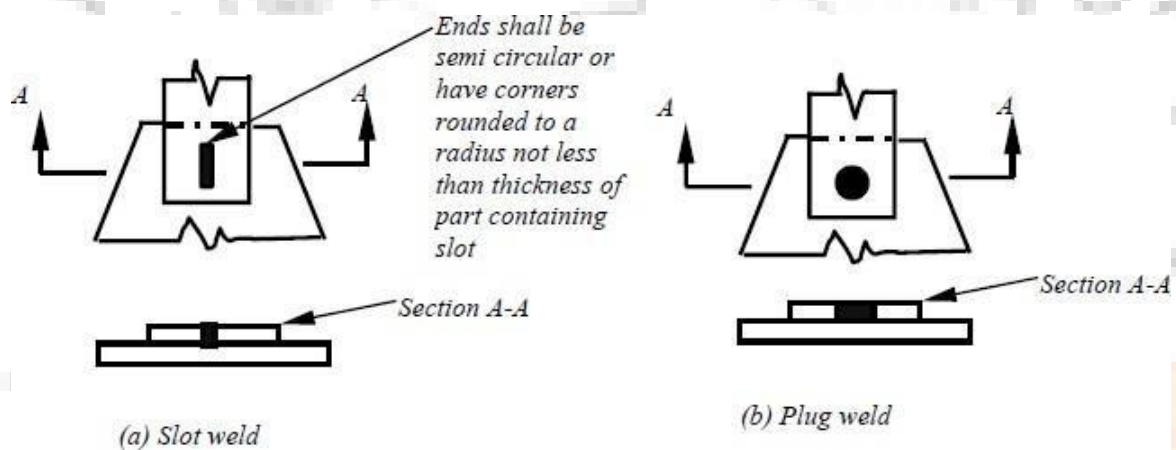

Figure 8.13 Slot and Plug welds

The limitations given in specifications for the maximum sizes of plug and slot welds are necessary to avoid large shrinkage, which might be caused around these welds when they exceed the specified sizes. The strength of a plug or slot weld is calculated by considering the allowable stress and its nominal area in the shearing plane. This area is usually referred to as the faying surface and is equal to the area of contact at the base of the slot or plug. The length of the slot weld can be obtained from the following relationship:

$L = \text{Load} / (\text{width}) \text{ allowable stress}$

Eccentric joints

In some cases, eccentric loads may be applied to fillet welds causing either shear and torsion or shear and bending in the welds. Examples of such loading are shown in Fig. 8.14. These two common cases are treated in this section.

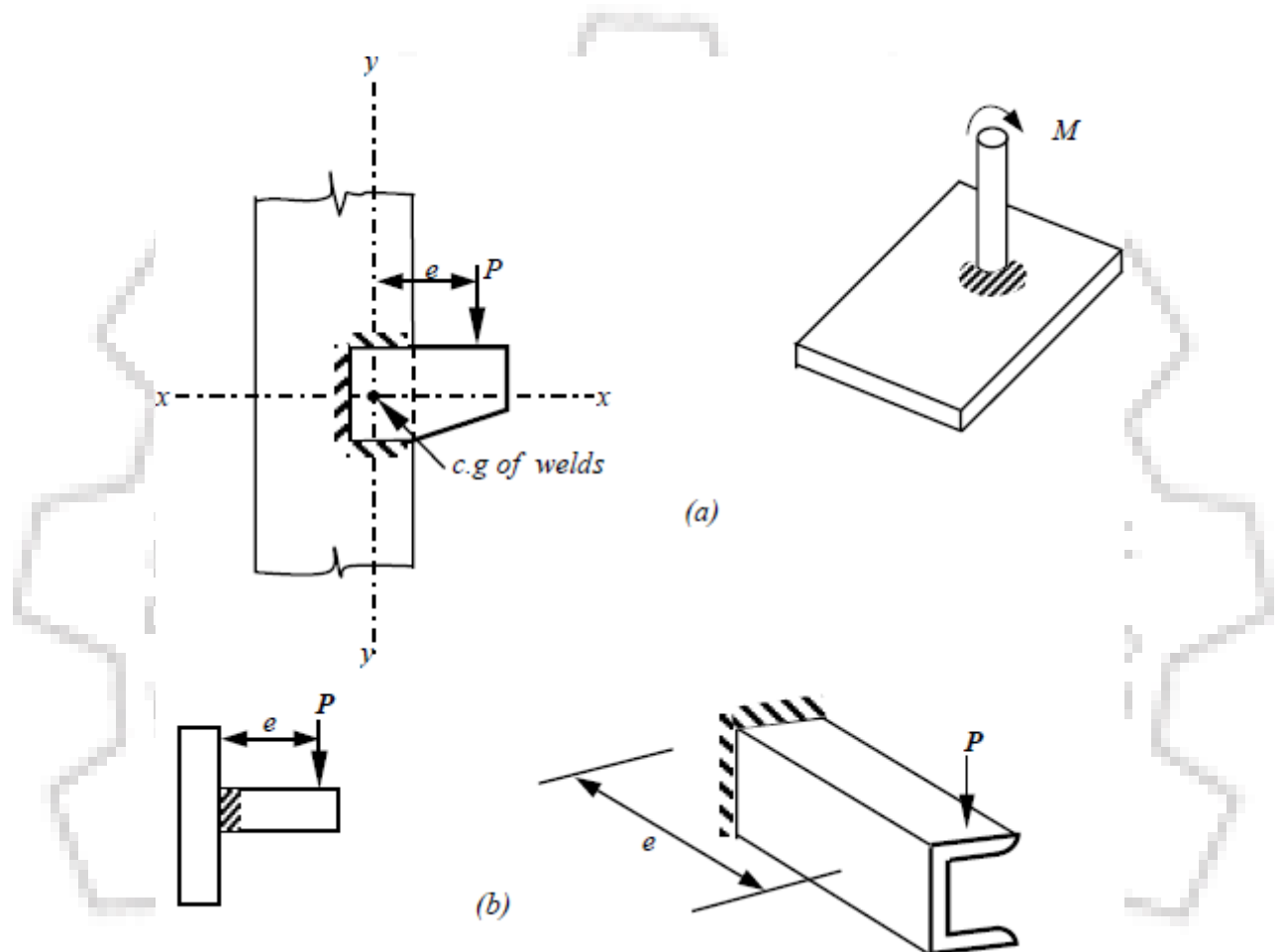

Figure 8.14 (a) Welds subjected to shear and torsion, (b) Welds subjected to shear and bending

Shear and torsion

Considering the welded bracket shown in Fig. 8.14(a), an assumption is made to the effect that the parts being joined are completely rigid and hence all the deformations occur in the weld. As seen from the figure, the weld is subjected to a combination of shear and torsion. The force caused by torsion is determined using the formula

$$F = T.s/J = (\text{Moment} / \text{Polar moment of inertia})$$

where, T is the tension, s is the distance from the centre of gravity of the weld to the point under consideration, and J is the polar moment of inertia of the weld. For convenience, the force can be decomposed into its vertical and horizontal components:

$$F_h = Tv/J \text{ and } f_v = Th/J$$

where, v and h denote the vertical and horizontal components of the distance s . The stress due to shear force is calculated by the following expression

$$\tau = R/L$$

where, τ is the shearing stress and R is the reaction and L is the total length of the weld. While designing a weld subjected to combined shear and torsion, it is a usual practice to assume a unit size weld and compute the stresses on a weld of unit length. From the maximum weld force per unit length the required size of the fillet weld can be calculated.

Shear and bending

Welds, which are subjected to combined shear and bending are shown in Fig. 8.14(b). It is a common practice to treat the variation of shear stress as uniform if the welds are short. But, if the bending stress is calculated by the flexure formula, the shear stress variation for vertical welds will be parabolic with a maximum value equal to 1.5 times the average value. These bending and shear stress variations are shown in Fig. 8.15.

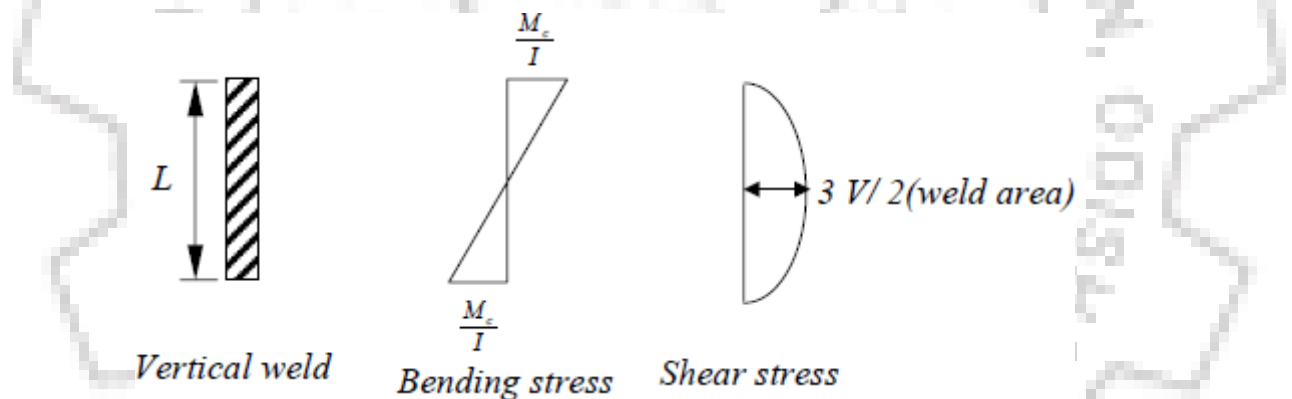

Figure 8.15 Variation of bending and shear stress

It may be observed here that the locations of maximum bending and shearing stresses are not the same. Hence, for design purposes the stresses need not be combined at a point. It is generally satisfactory if the weld is designed to withstand the maximum bending stress and the maximum shear stress separately. If the welds used are as shown in Fig. 8.16, it can be safely assumed that the web welds would carry all the of the shear and the flange welds all of the moment.



Figure 8.16 Weld provision for carrying shear and moment

Truss connections

Connections are very important in structural steelwork design. Therefore, the type of connections has to be finalized at the conceptual stage of the design to achieve maximum economy. This is especially true in the case of trusses. Efficient sections for the members alone do not result in economy unless suitable and economic connections are also designed.

Fabrication cost of connections would depend on the following factors.

- Precise cutting to length of sections (minimization of wasted length)
- Requirement of weld preparation
- Requirement of close control on weld root gaps
- Need for stiffening of the connection
- Chosen weld type

If some of the rigours in connections can be avoided, their cost can be reduced contributing to overall economy. Thus, for the economy of the entire truss, close attention has to be paid to connections.

Planar trusses

In a conventional riveted or bolted truss work, gusset plates are generally provided at the connections. In a welded truss, it may be possible to omit the gusset plates. Tees or angles with unequal legs are normally used for the top and bottom chord members. The web member angles may be welded directly to the vertical sides of the chord members (Fig. 8.17).

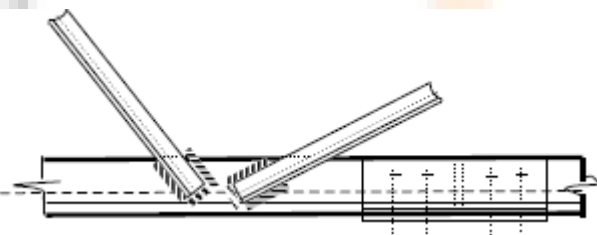

Figure 8.17 Direct connection of web members

When the trusses are very long, they may have to be fabricated in parts in fabrication shops. Such parts are assembled at site by bolting. Welded connection at the apex of a roof truss is shown in Fig. 8.18.

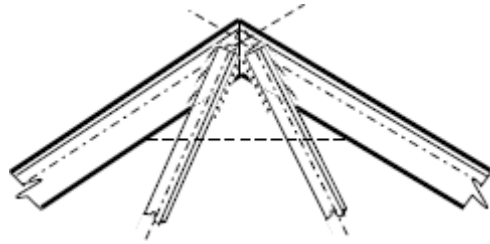

Figure 8.18 connection at the apex of a roof truss

The two rafters may either be butt welded together or a small plate is introduced at the connection facilitating fillet welding. If Tees are used for the rafters, the web members can be welded directly to the stalk of the Tees. Splices are sometimes provided in welded trusses for the purpose of transportation.

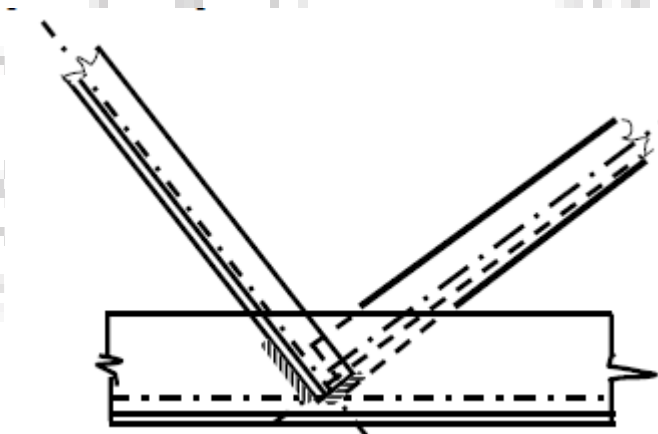

Figure 8.19 typical welded truss connection

It is often possible to forego the use of gusset plates by joining the members eccentrically. This provision makes the trusses economical by making the connection simple; the resulting penalty on the member size is marginal. Alternative method to avoid eccentricity is to join the web members on opposite sides of the truss [Fig. 8.19]. A typical eaves level connection is shown in Fig. 8.20. For low-pitch roofs, this would produce a long connection. To avoid such a connection, often the connection is truncated and the resulting eccentricity is accounted for in the design.

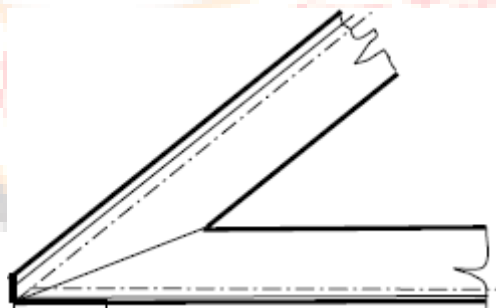

Figure 8.20 Eaves connection

Eccentricities in truss connections

Eccentricity in truss connections can occur due to two reasons: 1) element centroidal axes not intersecting at a point, and 2) connection centroid not coinciding with the element centroid.

Figure 8.21 shows the two cases of eccentricity. All the members joining the connection resist the moment caused by the eccentricity, P_e . It is distributed between them in proportion to their bending stiffness per unit length (I/l). Each member connecting to the joint should be designed to withstand the axial forces and its share of bending moment. If the connection centroids do not coincide with the member axes, they will be subjected to additional moments.

A simple way to consider both moments due to eccentricity is to design for axial load and then use interaction diagrams for weld groups subject to combined loading to determine the increase in weld size required to include the moments. It is often observed that there is minimal reduction in axial capacity. This could be comfortably absorbed in the factor of safety usually assumed for connection design.

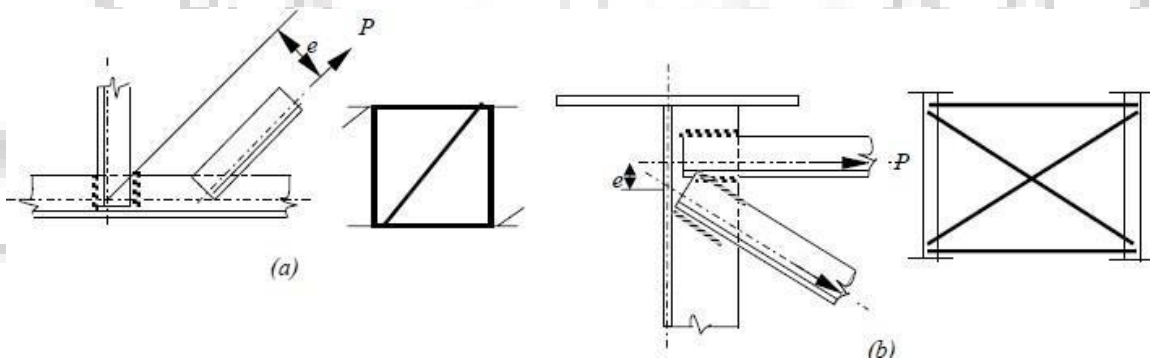

Figure 8.21 Eccentricities in truss connections (a) Pratt truss, (b) cross bracing between plate girders

Design of Fillet welds for truss members

In the design of welds connecting tension or compression members, the welds should be at least as strong as the members they connect and the connection should not result in significant eccentricity of loading. Truss members often consist of single or double angles and occasionally T-shapes and channels. Consider the angle tension member as shown in the Figure 8.22 below. With two longitudinal welds (on the two sides parallel to the axis of the load) and a transverse weld (perpendicular to the axis of the weld). The axial force T in the member will act along the centroid of the member. The force T has to be resisted by the forces P_1 , P_2 and P_3 developed by the weld lines. The forces P_1 and P_2 are assumed to act at edges of the angle and the force P_3 at the centroid of the weld length, located at $d/2$. Taking moments about point A located at the bottom edge of the member and considering clockwise moments as positive, we get

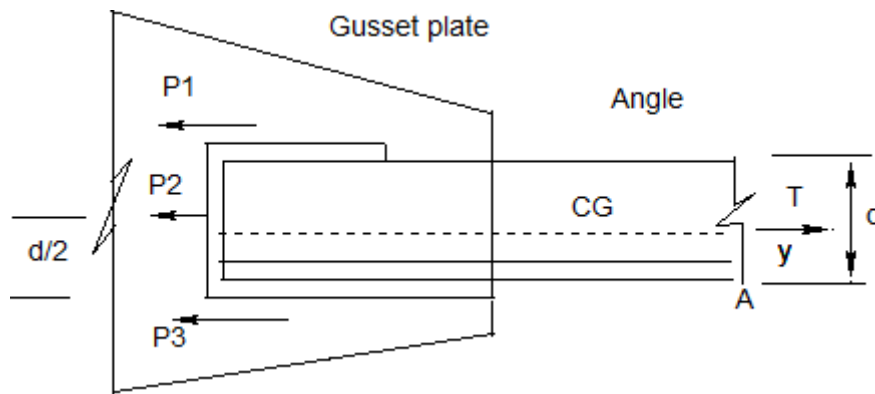

Figure 8.22 Balancing the welds on a tension member connection

$$\sum M_A = -P_1 d - P_2 d/2 + T y = 0$$

Hence

$$P_1 = T y / d - P_2 / 2$$

The force P_2 is equal to the resistance R_w of the weld per mm multiplied by the length L_w of the weld.

$$P_2 = R_w L_{w2}$$

Considering the horizontal equilibrium, we get

$$\sum F_H = T - P_1 - P_2 - P_3 = 0$$

Solving the above equations simultaneously, we get

$$P_3 = T (1 - y / d) - P_2 / 2$$

Designing the connection shown in the above Figure 8.22, to eliminate the eccentricity caused by the unsymmetrical welds is called balancing the weld. The procedure adopted for balancing the weld is as follows:

1. After selecting the proper weld size and electrode, compute the force resisted by the end weld P_2 if any
2. Compute P_1
3. Compute P_3
4. Compute the lengths L_{w1} and L_{w3} on the basis of

$$L_{w1} = P_1 / R_w \text{ and } L_{w3} = P_3 / R_w$$

Alternatively the total length required to resist the load L_w may be calculated. The length of end weld may then be subtracted from the total and the remaining length is allocated to P_1 and P_2 in inverse proportion to the distances from the centre of gravity.

Problem 3: A tie member of a truss consisting of an angle section ISA 65 x 65 x 6 of Fe 410 grade is welded to an 8 mm gusset plate. Design a weld to transmit a load equal to the full strength of the member. Assume shop welding.

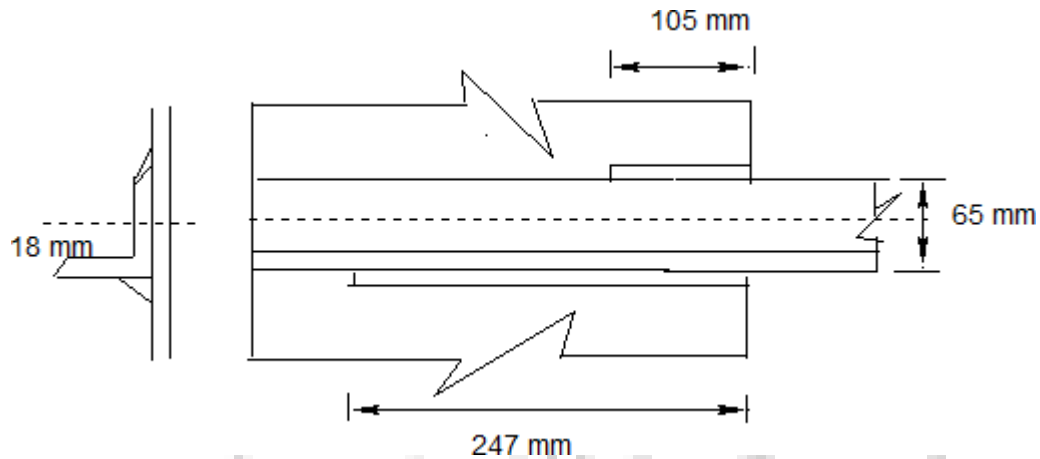

Solution:

From IS Handbook no.1 or IS 808, the properties of ISA 65 x 65 x 6 are

$$A=744 \text{ mm}^2$$

$$C_z= 18.1 \text{ mm}$$

$$\text{Tensile capacity of the member} = 744 \times 250/1.1 = 169.1 \text{ KN}$$

The force resisted by the weld at the lower side of the angle

$$P_1= 169.1 \times (65-18.1)/65= 122.01 \text{ KN}$$

Force to be resisted by the upper side of the angle

$$P_2 = 169.1 \times 18.1/65 = 47.09 \text{ KN}$$

Assuming a weld size of 4 mm (> 3 mm)

$$\text{Effective throat thickness of the weld} = 0.7 \times 4 = 2.8 \text{ mm}$$

$$\text{Strength of the weld} = 2.8 \times 410 / (\text{sqrt}(3) \times 12.5) = 530 \text{ N/mm}$$

$$L_{w1} = 122.01 \times 10^3 / 530 = 230.1 \text{ mm}$$

Hence provide $230.1 + (2 \times 4) = 246.1 \text{ mm}$, say 247 mm length at the bottom

$$L_{w2} = 47.09 \times 10^3 / 530 = 88.8 \text{ mm}$$

Provide $88.8 + (2 \times 4) \times 2 = 104.8$ mm, say 105 mm length at top.

Example 4: Design a joint according to the instructions given in Example 3. If the welding is done on three sides of the angle as shown below.

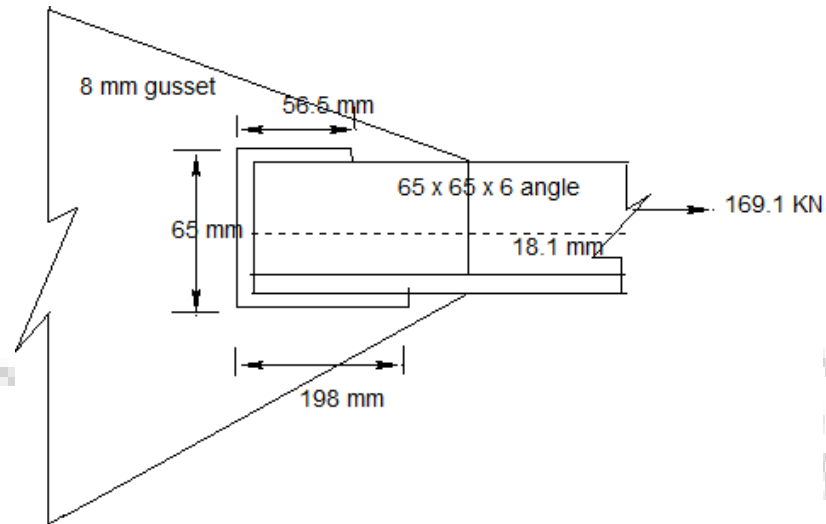

Solution:

$$\text{Strength of 4 mm weld} = 2.8 \times 410 / (\sqrt{3}) \times 1.25 = 530 \text{ N/mm}$$

$$P_2 = 530 \times 65 / 1000 = 34.45 \text{ KN}$$

$$P_1 = T_y/d - P_2/2 = 169.1 \times 18.1 / 65 - 34.45 / 2 = 29.86 \text{ KN}$$

$$P_3 = T - P_1 - P_2 = 169.1 - 29.86 - 34.45 = 104.79 \text{ KN}$$

$$L_{w1} = 29.86 \times 1000 / 530 = 56.3 \text{ mm say } 56.5 \text{ mm}$$

$$L_{w3} = 104.79 \times 1000 / 530 = 197.7 \text{ mm, say } 198 \text{ mm}$$

$$\text{Total length of weld} = 65 + 56.5 + 198 = 319.5 \text{ mm}$$

Check for block shear failure

Since the member is welded to the gusset plate, no net areas are involved and hence A_{vn} and A_{tn} in the equation for T_{db} should be taken to be the corresponding gross areas. Using the weldment with $L_1 = 198$ mm $L_2 = 56.5$ mm and 65 mm at the end of the angle yields

$$T_{db1} = [8 \times (198 \times 2) \times 250 / (\sqrt{3}) \times 1.1 + 0.9 \times 410 \times 8 \times 65 / 1.25] / 1000 = 569.2 \text{ KN}$$

$$T_{db2} = [0.9 \times 410 \times (198 \times 2 / (\sqrt{3}) \times 1.25) + 250 \times 8 \times 65 / 1.1] / 1000 = 658.1 \text{ KN}$$

Hence

$$T_{db} = 569.2 \text{ KN} > 169.1 \text{ KN}$$

Hence, the thickness of gusset plate is adequate.

Note: L_2 does not enter into this calculation because a shear rupture of the gusset plate along the toe of the angle runs for the full length of the contact with the toe, 198 mm in stead of only the length L_2 .





Tie Rods in Structures

Introduction

Tension members are linear members in which axial forces act so as to elongate (stretch) the member. A rope, for example, is a tension member. Tension members carry loads most efficiently, since the entire cross section is subjected to uniform stress. Unlike compression members, they do not fail by buckling (see chapter on compression members). Ties of trusses [Fig 9.1(a)], suspenders of cable stayed and suspension bridges [Fig. 9.1 (b)], suspenders of buildings systems hung from a central core [Fig. 9.1(c)] (such buildings are used in earthquake prone zones as a way of minimising inertia forces on the structure), and sag rods of roof purlins [Fig 9.1(d)] are other examples of tension members.

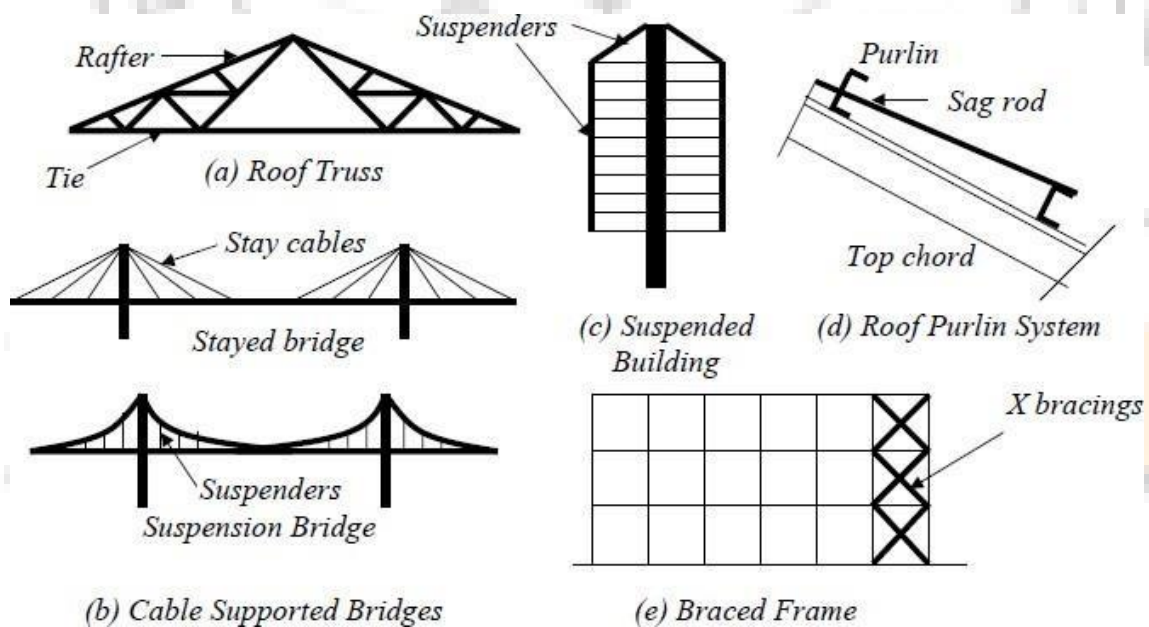

Figure 9.1 Tension Members in Structures

Tension members are also encountered as bracings used for the lateral load resistance. In X type bracings [Fig.1 (e)] the member which is under tension, due to lateral load acting in one direction, undergoes compressive force, when the direction of the lateral load is changed and vice versa. Hence, such members may have to be designed to resist tensile and compressive forces.

The tension members can have a variety of cross sections. The single angle and double angle sections [Fig 9.2(a)] are used in light roof trusses as in industrial buildings. The tension members in bridge trusses are made of channels or I sections, acting individually or built-up [Figs. 9.2(c) and 9.2(d)]. The circular rods [Fig. 9.2 (d)] are used in bracings designed to resist loads in tension only. They buckle at very low compression and are not considered effective. Steel wire ropes [Fig. 9.2 (e)] are used as suspenders in the cable suspended bridges and as main stays in the cable-stayed bridges.

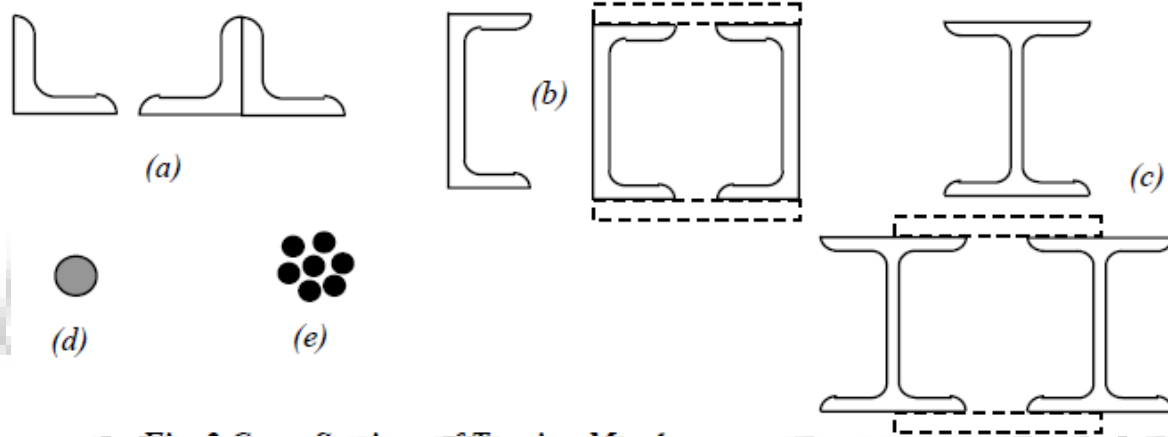

Figure 9.2 Cross section of tension members

Slenderness Ratio (Table 9.1)

Although stiffness is not required for the strength of a tension member, a minimum stiffness is stipulated by limiting the maximum slenderness ratio of the tension member.

Table 9.1 Slenderness ratio for tension members

Member	Maximum effective slenderness ratio (L/r)
A tension member in which a reversal of direct stress occurs due to loads other than wind or seismic forces	180
A member subjected to compressive forces resulting only from a combination of wind/earthquake actions, provided the deformation of such a member does not adversely affect the stresses in any part of the structure	250
A member normally acting as a tie in a roof truss or a bracing member, which is not considered effective when subject to reversal of stress resulting from the action of wind or earthquake forces	350
Members always in tension (other than pre-tensioned members)	400

Behaviour of tension members

Since axially loaded tension members are subjected to uniform tensile stress, their load deformation behaviour (Fig. 9.3) is similar to the corresponding basic material stress strain behaviour. Mild steel members (IS: 2062) exhibit an elastic range (a-b) ending at yielding (b). This is followed by yield plateau (b-c). In the Yield Plateau the load remains constant as the elongation increases to nearly ten times the yield strain. Under further stretching the material shows a smaller increase in tension with elongation (c-d), compared to the elastic range. This range is referred to as the strain hardening range. After reaching the ultimate load (d), the loading decreases as the elongation increases (de) until rupture (e). High strength steel tension members do not exhibit a well-defined yield point and a yield plateau (Fig.9.3). The 0.2% offset load, T , as shown in Fig. 9.3 is usually taken as the yield point in such cases.

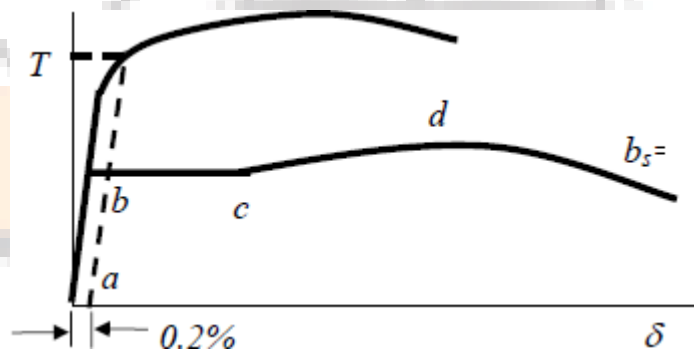
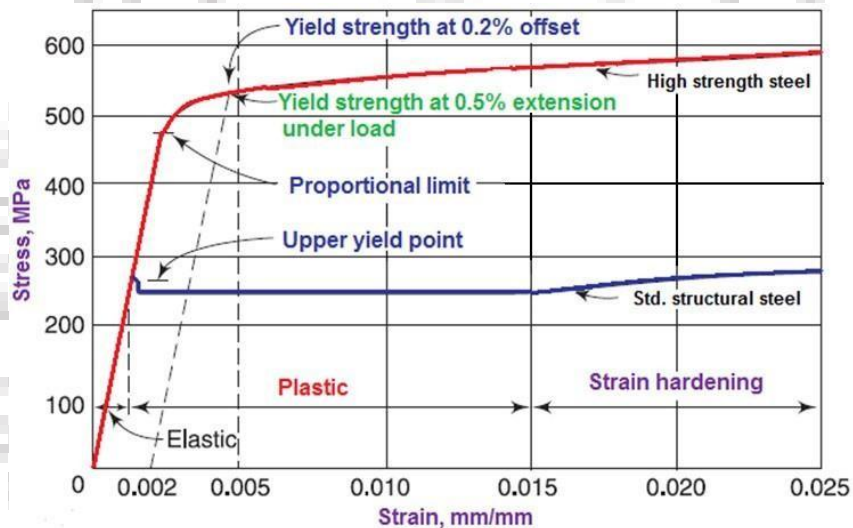

Figure 9.3 Load – Elongation of Tension Members

Design Of Tension Members

Tension members are linear members in which axial forces act to cause elongation (stretch). Such members can sustain loads up to the ultimate load, at which stage they may fail by rupture at a critical section. However, if the gross area of the member yields over a major portion of its length before the rupture load is reached, the member may become non-functional due to excessive elongation. Plates and other rolled sections in tension may also fail by block shear of end bolted regions

The factored design tension T , in the members shall satisfy the following requirement.

$$T \leq T_d \quad (9.1)$$

Where T_d = design strength of the member under axial tension, T_d is the lowest of the design strength due to the yielding of cross-section, T_{dg} , rupture of critical section T_{dn} and block shear failure, T_{db} .

Design Strength Due To Yielding Of Gross-Section

Tension yielding of the members at the gross cross-section is given by

$$T_{dg} = f_y A_g / \gamma_{m0} \quad (9.2a)$$

Where f_y is the yield stress of material in MPa, and A_g is the gross area of cross-section. γ_{m0} is the partial safety factor for failure in tension by yielding

Design Strength Due To Rupture Of Critical Section

Plates

Tension rupture of the plate at the net cross-section is given by

$$T_{dn} = 0.9 f_u A_n / \gamma_{m1} \quad (9.2b)$$

Where f_u is the ultimate stress of the material in MPa and A_n is the net effective area of the member given (as shown in the Figure 9.4 for the definition of variables). γ_{m1} is the partial safety factor for failure at ultimate stress

$$A_n = \left[b - n d_h + \sum_i \frac{p_i^2}{4g_i} \right] t$$

Where

b, t = width and thickness of the plate, respectively.

d_h = diameter of the bolt hole (2 mm in addition to the diameter of the hole, in case the directly punched holes),

g = gauge length between the bolt holes, as shown in Fig. 9.4,

p_s = staggered-pitch length between line of bolt holes, as shown in Fig. 9.4,
 n = number of bolt holes in the critical section, and
 i = subscript for summation of all the inclined legs

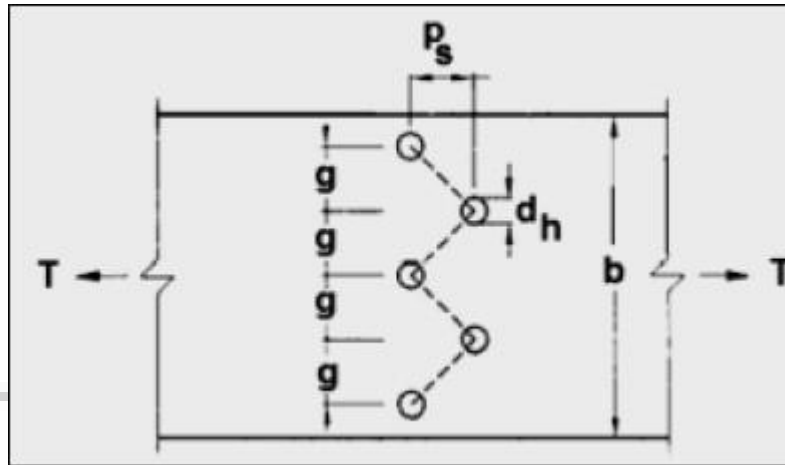

Figure 9.4 plate with the staggered holes in tension

The design strength of threaded rods in tension, T_{dn} , as governed by rupture is given by
 $T_{dn} = 0.9A_n f_u / \gamma_{m1}$

Where

A_n is the net root area at the threaded section

Single Angles

For angle members connected through one leg, the design rupture strength T_{dn} , is calculated as:

$$T_{dn} = 0.9 A_{nc} f_u / \gamma_{m1} + \beta A_{go} f_y / \gamma_{m0}$$

Where

$$\beta = 1.4 - 0.076(w/t)(f_y / f_u)(b_s / L_c) \leq (f_u \gamma_{m0} / f_y \gamma_{m1}) \geq 0.7$$

w = outstand leg width

b_s = shear lag width, as shown in Fig. 9.5, and

L_c = length of the end connection, that is the distance between the outermost bolts in the end joint measured along the load direction or length of the weld along the load direction.

For preliminary sizing, the rupture strength of net section may be approximately taken as:

$$T_{dn} = \alpha A_n f_u / \gamma_{m1}$$

Where

$\alpha = 0.6$ for one or two bolts, 0.7 for three bolts and 0.8 for four or more bolts along the length in the end connection or equivalent weld length;

A_n = net area of the total cross-section;

A_{nc} = net area of the connected leg;

A_{go} = gross area of the outstanding leg; and

t = thickness of the leg.

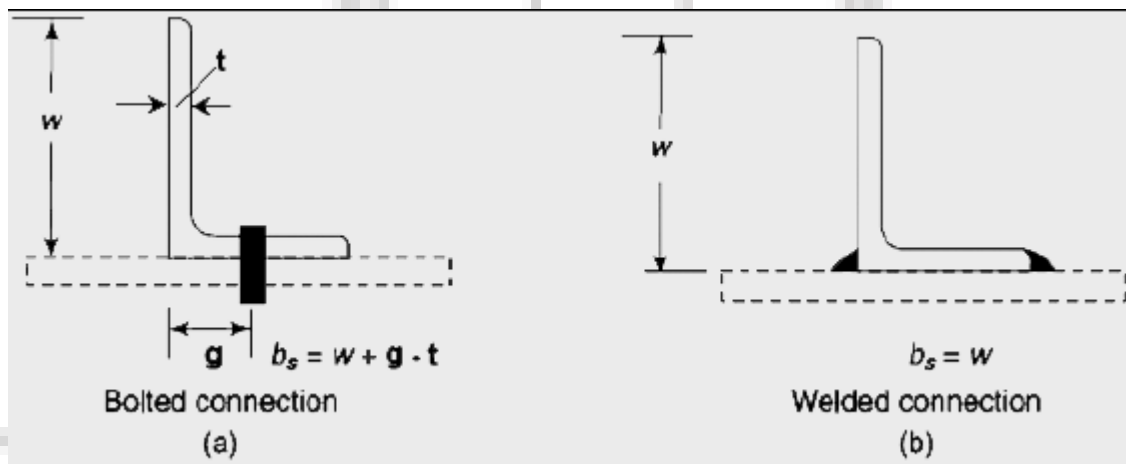

Figure 9.5 Angles with single leg connections

Other Sections

The rupture strength, T_{dn} , of the double angles, channels, I-sections and other rolled steel sections, connected by one or more elements to an end gusset is also governed by shear lag effects. The design tensile strength of such sections as governed by tearing of net section may also be calculated using equation in 9.4.3, where β is calculated based on the shear lag distance, b_s , taken from the farthest edge of the outstanding leg to the nearest bolt/weld line in the connected leg of the cross-section.

Design Strength Due to Block Shear

Block shear failure was recognized as a failure mode first in 1978, when Birkemoe and Gilmore conducted tests on coped beams with bolted web connections, and incorporated in AISC specifications in 1978. Block shear failure in angles were investigated after the failure of Hartford Civic Center roof, Connecticut in 1978. Block shear failure in bolted / welded connections is characterized by a condition, where a "block" of material, in a pattern surrounding the bolted region, reaches its capacity through a combination of tension and shear. If the connection is loaded further, the block is eventually displaced from the connection region (see Fig. 9.6). Block shear is usually initiated with tension fracture. The block shear strength, T_{db} of the connection shall be smaller of

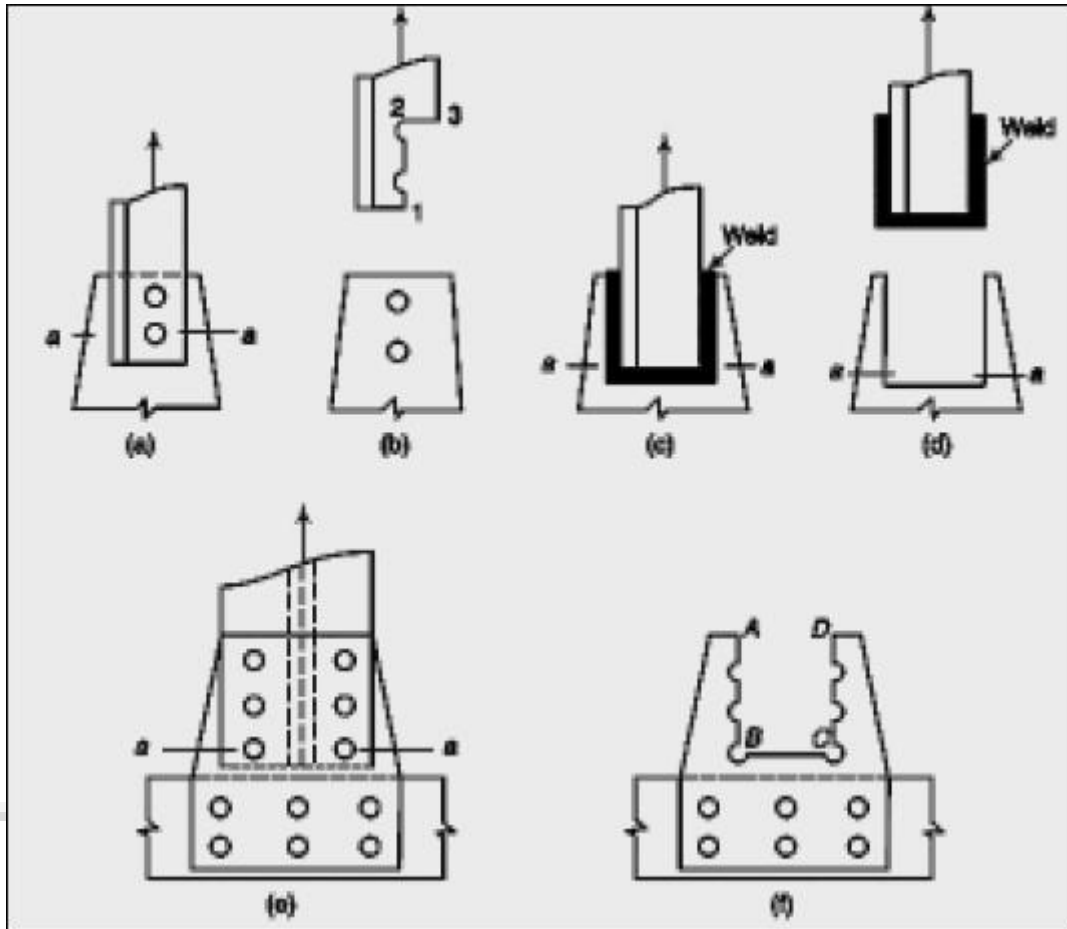

Figure 9.6 Examples Of Block Shear Failures

$$T_{db} = \left[A_{vg} f_y / (\sqrt{3} \gamma_{m0}) + 0.9 A_{tn} f_u / \gamma_{m1} \right]$$

Or

$$T_{db} = \left[0.9 A_{vn} f_u / (\sqrt{3} \gamma_{m1}) + A_{tg} f_y / \gamma_{m0} \right]$$

A_{vg} and A_{vn} = minimum gross and net area in shear along a line of transmitted force, respectively (along 1-2 in Fig. 9.6a or along A-B and D-C in Fig. 9.6f), A_{tg} and A_{tn} = minimum gross and net area in tension from the hole to the toe of the angle, or next last row of bolts in plates perpendicular to the line of force, respectively (along 2-3 in Fig. 9.6a or along B-C in Fig. 9.6f).

It may be of interest to note that the American code has adopted the following block shear formula for angles, with a resistance factor of $\phi = 0.75$

$$\phi T_n = \phi \left[0.6 f_y A_{vg} + 0.5 f_u A_{tn} \right]$$

with

$$0.6 f_u A^{vg} = 0.6 f_u A_{vn}$$



Bolted Connections

Introduction

Connections form an important part of any structure and are designed more conservatively than members. This is because, connections are more complex than members to analyse, and the discrepancy between analysis and actual behaviour is large. Further, in case of overloading, we prefer the failure confined to an individual member rather than in connections, which could affect many members. Connections account for more than half the cost of structural steelwork and so their design and detailing are of primary importance for the economy of the structure. The type of connection designed has an influence on member design and so must be decided even prior to the design of the structural system and design of members. For example, in the design of bolted tension members, the net area is calculated assuming a suitable number and diameter of bolts based on experience. Therefore, it is necessary to verify the net area after designing the connection. Similarly in the analysis of

frames, the member forces are determined by assuming the connections to be pinned, rigid, or semirigid, as the actual behaviour cannot be precisely defined.

Just as members are classified as bending members or axially loaded members depending on the dominant force/moment resisted, connections are also classified into idealised types while designing. But the actual behaviour of the connection may be different and this point should always be kept in mind so that the connection designed does not differ significantly from the intended type. Take for example, the connection of an axially loaded truss member at a joint. If the truss is assumed to be pin jointed, then the member should ideally be connected by means of a single pin or bolt. However, in practice, if the pin or bolt diameter works out to be larger than that possible, more than one bolt will be used. The truss can then be considered pin-jointed only if the bending due to self-weight or other superimposed loads is negligible. Note that the connection behaviour will also influence the calculation of the effective length for the buckling analysis of struts.

The connections provided in steel structures can be classified as 1) riveted 2) bolted and 3) welded connections. Riveted connections were once very popular and are still used in some cases but will gradually be replaced by bolted connections. This is due to the low strength of rivets, higher installation costs and the inherent inefficiency of the connection. Welded connections have the advantage that no holes need to be drilled in the member and consequently have higher efficiencies. However, welding in the field may be difficult, costly, and time consuming. Welded connections are also susceptible to failure by cracking under repeated cyclic loads due to fatigue which may be due to working loads such as trains passing over a bridge (high-cycle fatigue) or earthquakes (low-cycle fatigue). A special type of bolted connection using High Strength Friction Grip (HSFG)

bolts has been found to perform better under such conditions than the conventional black bolts used to resist predominantly static loading. Bolted connections are also easy to inspect and replace. The choice of using a particular type of connection is entirely that of the designer and he should take his decision based on a good understanding of the connection behaviour, economy and speed of construction.

Bolted Connections

Connections can also be classified in the following ways:

(a) Classification based on the type of resultant force transferred: The bolted connections are referred to as concentric connections (force transfer in tension and compression member), eccentric connections (in reaction transferring brackets) or moment resisting connections (in beam to column connections in frames).

Ideal concentric connections should have only one bolt passing through all the members meeting at a joint [Fig. 10.1(a)]. However, in practice, this is not usually possible and so it is only ensured that the centroidal axes of the members meet at one point [See Fig. 10.1(b)].

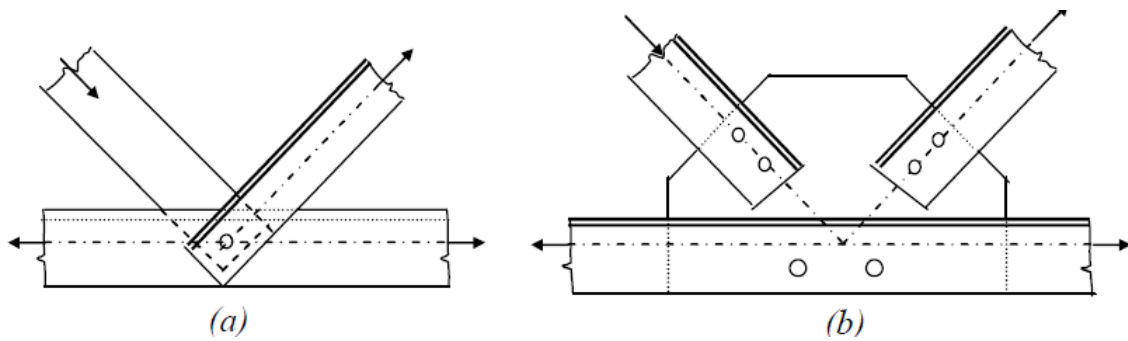

Figure 10.1 Concentric connections

The Moment connections are more complex to analyse compared to the above two types and are shown in Fig. 10.2(a) and Fig.10.2(b). The connection in Fig. 10.2(a) is also known as bracket connection and the resistance is only through shear in the bolts.

The connection shown in Fig. 10.2(b) is often found in moment resisting frames where the beam moment is transferred to the column. The connection is also used at the base of the column where a base plate is connected to the foundation by means of anchor bolts. In this connection, the bolts are subjected to a combination of shear and axial tension.

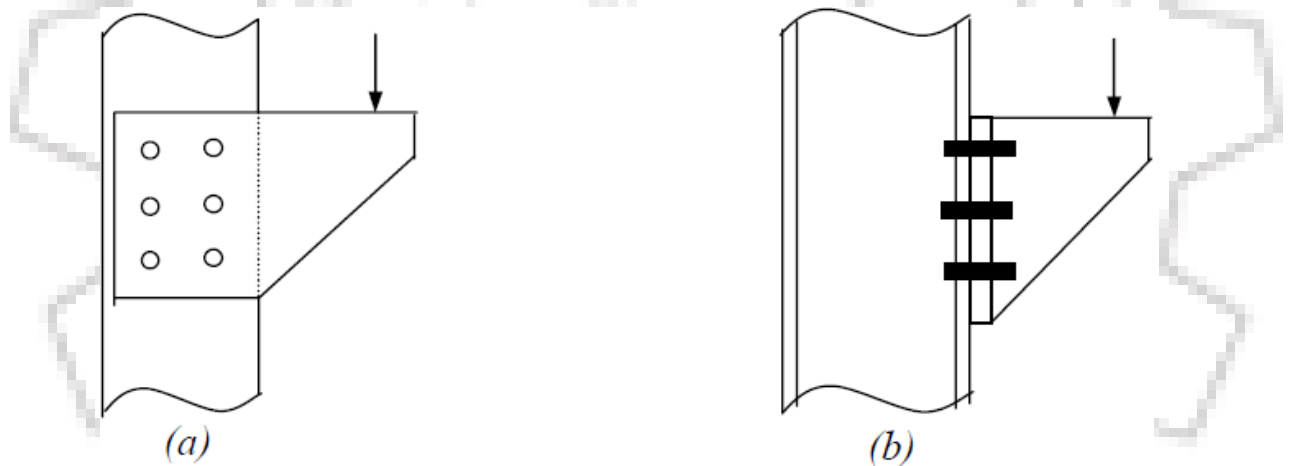

Figure 10.2 Moment Connections

(b) Classification based on the type of force experienced by the bolts: The bolted connections can also be classified based on geometry and loading conditions into three types namely, shear connections, tension connections and combined shear and tension connections.

Typical shear connections occur as a lap or a butt joint used in the tension members [See Fig. 10.3]. While the lap joint has a tendency to bend so that the forces tend to become collinear, the butt joint requires cover plates. Since the load acts in the plane of the plates, the load transmission at the joint will ultimately be through shearing forces in the bolts. In the case of lap joint or a single cover plate butt joint, there is only one shearing plane, and so the bolts are said to be in single shear. In the case of double cover butt joint, there are two shearing

planes and so the bolts will be in double shear. It should be noted that the single cover type butt joint is nothing but lap joints in series and also bends so that the centre of the cover plate becomes collinear with the forces.

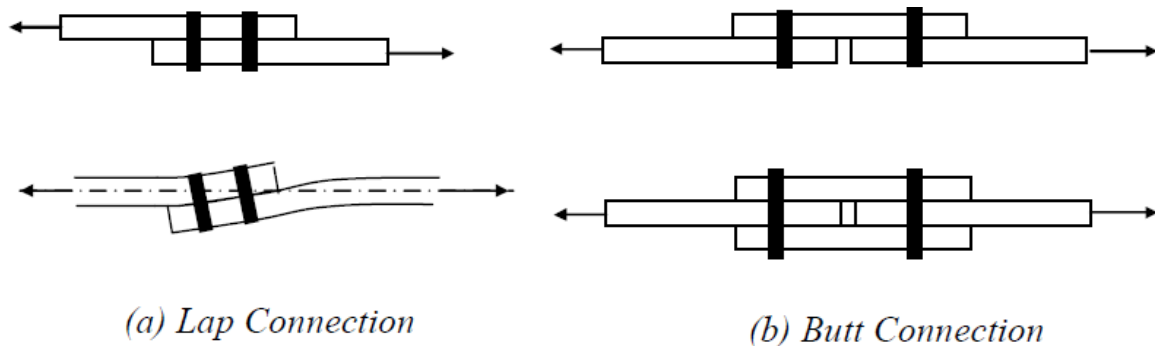

Figure 10.3 Shear connections

A hanger connection is shown in Fig. 10.4(a). In this connection, load transmission is by pure tension in the bolts. In the connection shown in Fig. 10.4(b), the bolts are subjected to both tension and shear.

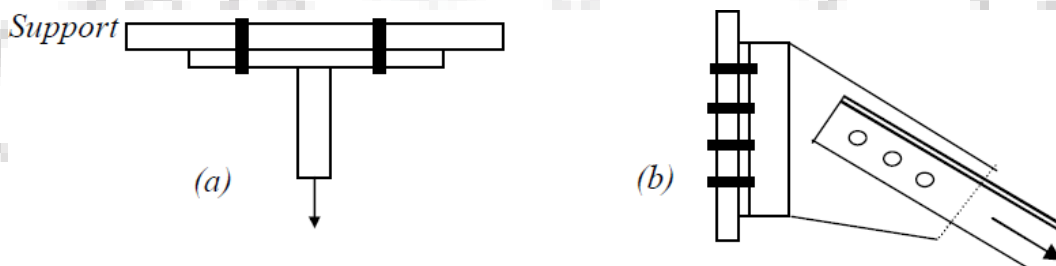

Figure 10.4 (a) Tension Connection (b) Tension plus Shear Connection

(c) Classification based on force transfer mechanism by bolts: The bolted connections are classified as bearing type (bolts bear against the holes to transfer the force) or friction type (force transfer between the plates due to the clamping force generated by the pre-tensioning of the bolts).

Bolts and Bolting

Bolts used in steel structures are of three types: 1) Black Bolts, 2) Turned and Fitted Bolts and 3) High Strength Friction Grip (HSFG) Bolts.

Black bolts (Figure 10.5) are unfinished and are made of mild steel and are usually of Grade 4.6. Black bolts have adequate strength and ductility when used properly; but while tightening the nut snug tight (“Snug tight” is defined as the tightness that exists when all plies in a joint are in firm contact) will twist off easily if tightened too much. Turned –and- fitted bolts have uniform shanks and are inserted in close tolerance drilled holes and made snug

tight by box spanners. The diameter of the hole is about 1.5 to 2.0 mm larger than the bolt diameter for ease in fitting. High strength black bolts (grade 8.8) may also be used in connections in which the bolts are tightened snug fit.



Figure 10.5 Black ordinary bolt or nut

These bolts are primarily used in light structures under static loads such as temporary fasteners during erection where HSFG bolts or welding are used as permanent fasteners. They are not recommended for connections subjected to impact, fatigue or dynamic loads. These bolts are made from mild steel rods with a square or hexagonal head and nuts as shown in Figure 10.6 conforming to IS 1363.

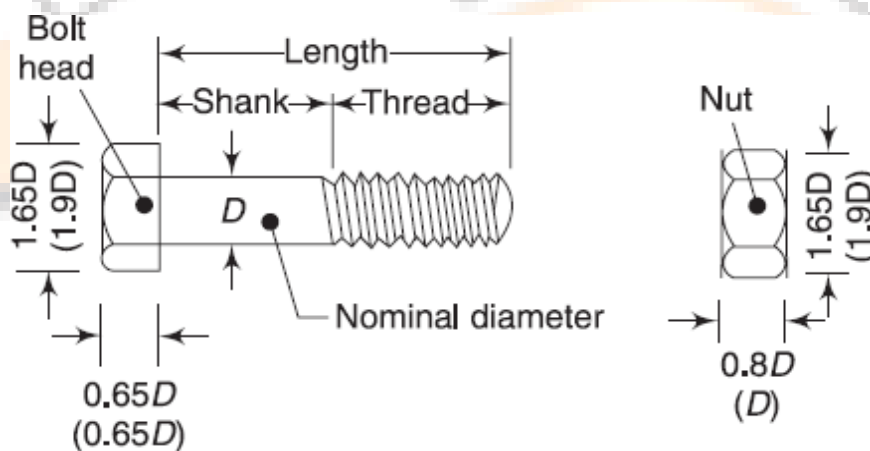

Figure 10.6 Hexagonal head black bolt and nut (IS 1363)

The International Standards Organisation designation for bolts, also followed in India, is given by Grade x.y. In this nomenclature, x indicates one-tenth of the minimum ultimate tensile strength of the bolt in kgf/mm² and the second number, y, indicates one-tenth of the ratio of the yield stress to ultimate stress, expressed as a percentage. Thus, for example, grade 4.6 bolt will have a minimum ultimate strength 40 kgf/mm² (392 Mpa) and minimum yield strength of 0.6 times 40, which is 24 kgf/mm² (235 Mpa). The tensile properties of fasteners used in steel construction are listed in Table 10.1.

Table 10.1 Tensile Properties of Fasteners

Specification	Grade/ classification	Properties		
		Yield stress, MPa (Min)	Ultimate tensile stress, MPa (Min)	Elongation percent- age (Min)
IS: 1367-1991	4.6	240	400	22
(ISO 898)	4.8	320	400	14
Specifications of	5.6	300	500	20
fasteners-threaded	5.8	400	500	10
steel for technical	8.8	640	800	12
supply conditions	10.9	900	1000	9

For grade 4.6 bolts, nuts of grade 4 are used and for grade 8.8, nuts of grade 8 or 10 are used

In these bearing type of connections, the plates are in firm contact but may slip under loading until the hole surface bears against the bolt. The load transmitted from plate to bolt is therefore by bearing and the bolt is in shear. Under dynamic loads, the nuts are liable to become loose and so these bolts are not allowed for use under such loading. In situations where small slips can cause significant effects as in beam splices, black bolts are not preferred. However, due to the lower cost of the bolt and its installation, black bolts are quite popular in simple structures subjected to static loading.

Though square heads cost less, hexagonal heads give better appearance, are easier to hold by wrenches, require less turning space. Most of the connections with black bolts are made by inserting them in clearance holes of about 1.5mm to 2 mm more than the bolt diameter and by tightening them with nuts. They are produced in metric sizes ranging from 5-36 mm and designed as M5 to M36. In Structural steel work M16, M20, M24 and M30 bolts are often used. The bolts used in steel work have a coarse pitch of thread, that is, 2, 2.5, 3 and 3.5 mm for 16, 20, 24 and 30 mm diameter bolts respectively. The ratio of net tensile area at threads to nominal plain shank area of the bolt is 0.78 as per IS 1367 (Part I). The other dimensions are given in Table 10.2

Table 10.2 Dimensions of Grade 4.6- Hexagon Head Bolts (IS 1364)

Bolt size (<i>d</i>), mm	Head diagonal (<i>e</i>), mm	Head thickness (<i>k</i>), mm	Thread* length (<i>b</i>), mm	Pitch of thread, mm	Washer (IS: 5370-1969)		
					Outer diameter, mm	Inner diameter, mm	Thickness, mm
(12)	20.88	8	20	1.75	24	14	3
16	26.17	10	23	2.0	30	18	3
20	32.95	13	26	2.5	37	22	3
(22)	35.03	14	28	2.5	39	24	3
24	39.55	15	30	3.0	44	26	4
(27)	45.20	17	33	3.0	50	30	4
30	50.85	19	35	3.5	56	33	4
36	60.79	23	40	4.0	66	39	5

*For length $l \leq 125$ mm. For $125 < l \leq 200$, b is 6 mm more and for $l > 200$, b is 19 mm more.

Turned and fitted bolts are available from grade 4.6 to grade 8.8. For the higher grades there is no definite yield point and so 0.2% proof stress is used..

High Strength Friction Grip bolts (HSFG) provide extremely efficient connections and perform well under fluctuating/fatigue load conditions. These bolts should be tightened to their proof loads and require hardened washers to distribute the load under the bolt heads. The washers are usually tapered when used on rolled steel sections. The tension in the bolt ensures that no slip takes place under working conditions and so the load transmission from plate to the bolt is through friction and not by bearing. However, under ultimate load, the friction may be overcome leading to a slip and so bearing will govern the design. The HSFG bolt, nut and washer dimensions are shown in Table 10.3 (Also see Figure 10.6 for approximate bolt dimensions).

HSFG bolts are made from quenched and tempered alloy steels with grades from 8.8 to 10.9. The most common are, the so-called, general grade of 8.8 and have medium carbon content, which makes them less ductile. The 10.9 grade have a much higher tensile strength, but lower ductility and the margin between the 0.2% yield strength and the ultimate strength is also lower.

The tightening of HSFG bolts can be done by either of the following methods:

1. Turn-of-nut tightening method: In this method the bolts are first made snug tight and then turned by specific amounts (usually either half or three-fourth turns) to induce tension equal to the proof load. Each nut is then tightened by a specified turn of the nut from the snug-tight position depending on the length of the bolt as specified in IS 400 (see Table 10.4 which

gives the minimum tension which should be available in the bolt after tightening). This is shown graphically in Figure 10.8.

2. Calibrated wrench tightening method: In this method the bolts are tightened by a wrench calibrated to produce the required tension.
3. Alternate design bolt installation: In this method special bolts are used which indicate the bolt tension. Presently such bolts are not available in India.
4. Direct tension indicator method: In this method special washers with protrusions are used [Fig.10.7(b)]. As the bolt is tightened, these protrusions are compressed and the gap produced by them gets reduced in proportion to the load. This gap is measured by means of a feeler gauge, consisting of small bits of steel plates of varying thickness, which can be inserted into the gap.

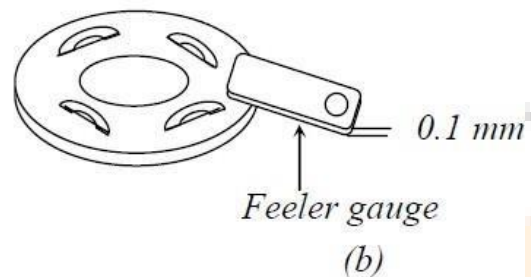
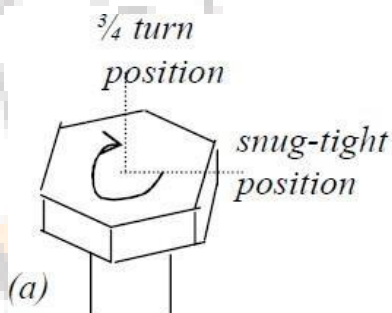

Figure 10.7 Tightening of HSFG bolts

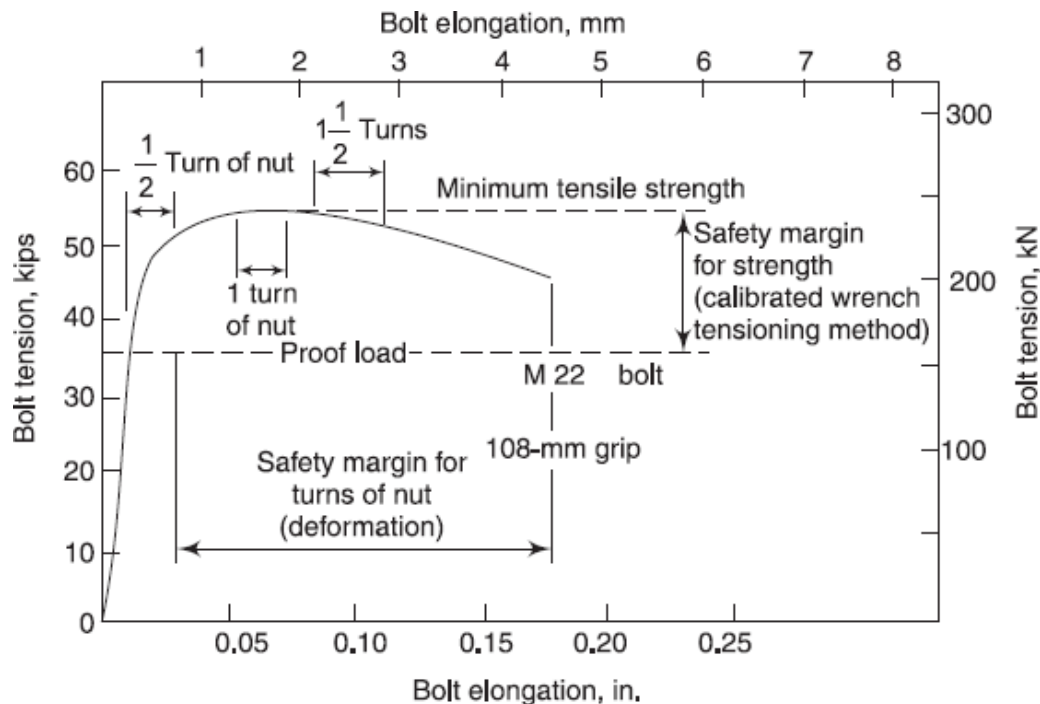

Figure 10.8 Relationship between induced tension/nut rotation for partial shank HSFG bolts

Advantages of Bolted Connections

Black Bolted connections offer the following advantages over riveted or welded connections:

- Use of unskilled labour and simple tools
- Noiseless and quick fabrication
- No special equipment/process needed for installation
- Fast progress of work
- Accommodates minor discrepancies in dimensions
- The connection supports loads as soon as the bolts are tightened (in welds and rivets, cooling period is involved).

Main drawback of black bolt is the slip of the joint when subjected to loading

Though the material cost of HSFG bolts are about 50 % higher than black bolts and require special workmanship for installation, they provide the following advantages.

- HSFG bolts do not allow any slip between the elements connected, especially in close tolerance holes (see Figure 10.9) providing rigid connections.
- Due to clamping action, load is transmitted by friction only and the holes are not subjected to shear and bearing.

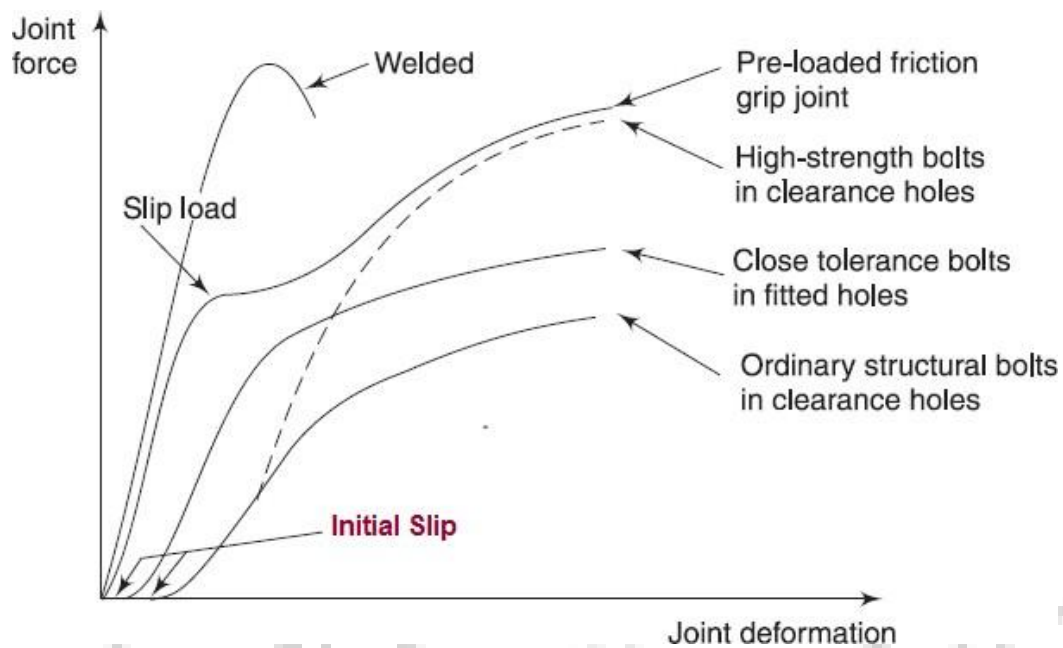

Figure 10.9 Load-Deformation Behaviour of Different Types of Fasteners

Bolt Holes

Since HSFG bolts under working loads, do not rely on resistance from bearing, holes larger than usual can be provided to ease erection and take care of lack-of-fit. Typical hole types that can be used are standard, extra large and short or long slotted. These are shown in Fig. 10.10. However the type of hole will govern the strength of the connection. Holes must also satisfy pitch and edge/end distance criteria. A minimum pitch is usually specified for accommodating the spanner and to limit adverse interaction between the bearing stresses on neighbouring bolts. Maximum pitch criteria takes care of buckling of the plies under compressive loads.

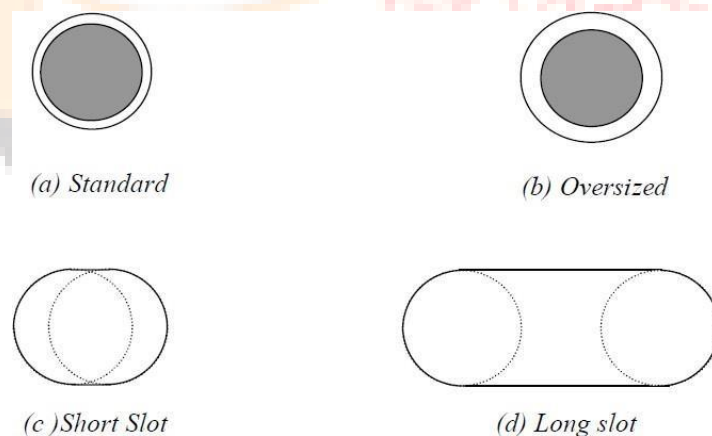

Figure 10.10 Hole types for HSFG bolts

Table 10.5 shows the standard values of holes for different bolt sizes (the clearance is 10 mm For bolts less than 14 mm and 2 mm for bolts between 16 mm and 24 mm and 3 mm for bolts exceeding 24 mm)

Table 10.3 High-Strength Bolts (IS 3757)

Diameter, d mm	M16	M20	(M22)	M24	(M27)	M30	M36
Head diagonal, e mm	29.56	37.29	39.55	45.20	50.85	55.37	66.44
Head thickness, k mm	10	12.5	14	15	17	18.7	22.5
Nut thickness, mm	13	16	18	19	22	24	26
Washer outer diameter, $*D$	30	37	39	44	50	56	60
Washer inner diameter, d mm	18	22	24	26	30	33	36
Washer thickness, mm	4	4	4	4	5	5	5
Thread length, $**b$ mm							
<100	31	36	38	41	44	49	56
>100	38	43	45	48	51	56	63

* The outside diameter of a washer is an important dimension when detailing, for example, to avoid overlapping an adjacent weld.

**The thread length depends on the length of the bolt, which is calculated as grip length plus the allowance for grip.



Table 10.4 Minimum Bolt tension and Nut rotation

Minimum Bolt Tension and Nut Rotation from Snug-Tight Condition (IS: 4000-1992).

Nominal size of bolt	Length of bolt,* mm		Minimum bolt tension in kN for bolts of property class	
	Nut rotation 1/2 turn	Nut rotation 3/4 turn	8.8	10.9
M16	≤ 120	>120 ≤ 280	90	112.5
M20	≤ 120	>120 ≤ 240	140	175
M24	≤ 160	>160 ≤ 350	202	253
M30	≤ 160	>160 ≤ 350	316	395
M36	≤ 160	> 160 ≤ 350	366	457

*Length is measured from the underside of the head to the extreme end of the shank.

Table 10.5 Bolt Dia, Pitch & Edge Distances as per IS 800

Nominal diameter of bolt, mm	12	14	16	18	20	22	24	27	30	Above 36
Diameter of hole, mm	13	15	18	20	22	24	26	30	33	Bolt diameter + 3 mm
Minimum edge distance,* mm										
(a) for sheared or rough edge	22	26	31	34	37	41	44	51	56	1.7 × hole diameter
(b) for rolled, sawn, or planed edge	18	23	27	30	33	36	39	45	50	1.5 × hole diameter

*The edge distances in this table, which are for standard holes, must be increased if oversize or slotted holes are used.

Max. edge distance = $12t\varepsilon$ where $\varepsilon = (250/f_y)^{0.5}$

Pitch (min.)	2.5 × nominal diameter of bolt
Pitch (max.)	32t or 300 mm
(a) parts in tension	16t or 200 mm, whichever is less
(b) parts in compression	12t or 200 mm, whichever is less
(c) tacking fasteners	<div style="border-left: 1px solid black; border-right: 1px solid black; padding-left: 10px;"> 32t or 300 mm, whichever is less 16t or 200 mm, whichever is less for plates exposed to weather </div>

where t is the thickness of the thinner outside plate or angle.

Spacing and Edge Distance of Bolt Holes

The centre-to-centre distance between individual fasteners in a line, in the direction of load/stress is called the pitch. The distance between any two consecutive fasteners in a zig-zag pattern of bolts measured parallel to the direction of load/stress is called a staggered pitch. A minimum spacing of 2.5 times the nominal diameter of the fastener is specified in the code to ensure that there is sufficient space to tighten the bolts, prevent overlapping of the washers, and provide adequate resistance to tear-out of the bolts. It also limits any adverse interaction between high bearing stresses due to neighbouring bolts. Similarly the code specifies maximum pitch values as given in Table 10.5. These values are specified to prevent buckling of plates in compression between the bolts, to ensure that the bolts act together as a group to resist the loads and to avoid corrosion by ensuring adequate bridging of the paint film between plates. The spacing between adjacent parallel line of fasteners transverse to the

direction of load/stress is called gauge distance. Figure 10.11 gives the gauge distance as specified in SP-1 published by the Bureau of Indian Standards.

Leg size	Double row of bolts		Single row of bolts c	Maximum bolt size for double row of bolts
	a	b		
mm	mm	mm	mm	mm
200	75	85	115	27
150	55	65	90	22
130	50	55	80	20
125	45	55	75	20
115	45	50	70	12
110	45	45	65	12
100	40	40	60	12
95	—	—	55	—
90	—	—	50	—
80	—	—	45	—
75	—	—	40	—
70	—	—	40	—
65	—	—	35	—
60	—	—	35	—
55	—	—	30	—
50	—	—	28	—
45	—	—	25	—
40	—	—	21	—
35	—	—	19	—
30	—	—	17	—
25	—	—	15	—
20	—	—	12	—

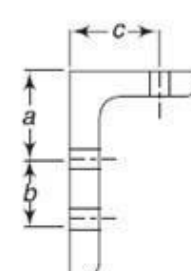

Figure 10.11 Gauge distance specified in special publication 1 (SP-1) of BIS

Behaviour of Bolted Joints

Loads are transferred from one member to another by means of the connections between them. A few typical bolted connections are shown in Figure 10.11

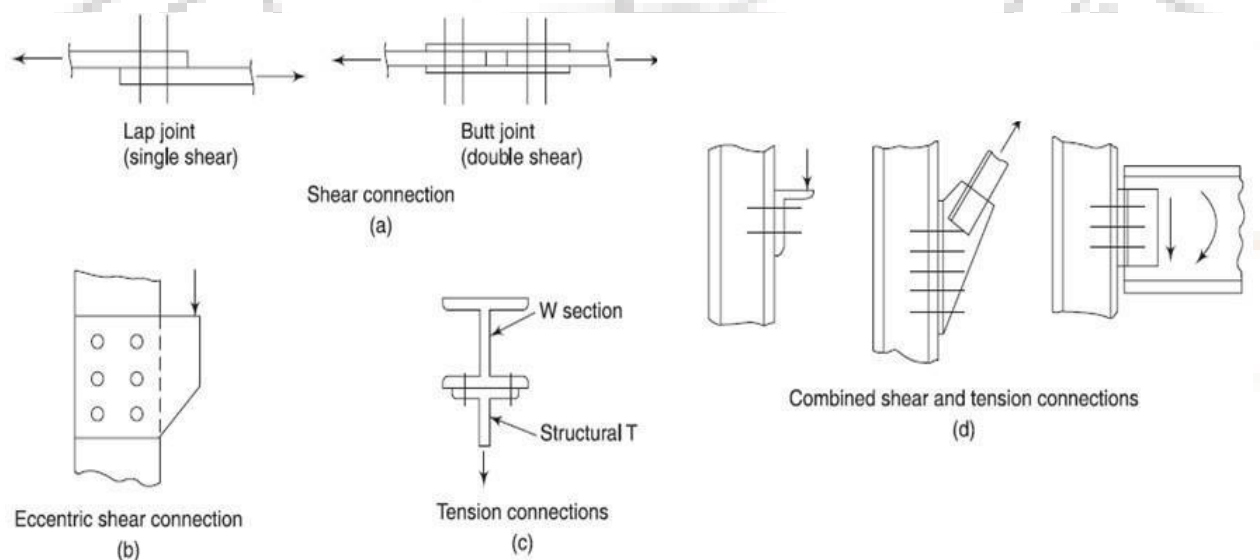

Figure 10.11 Typical bolted connections

The possible limit states or failure modes that may control the strength of a bolted connection is shown in Figure 10.12. Thus any joint may fail in any one of the following modes:

- Shear failure of bolt
- Shear failure of plate
- Bearing failure of bolt
- Bearing failure of plate
- Tensile failure of bolts
- Bending of bolts
- Tensile failure of plate

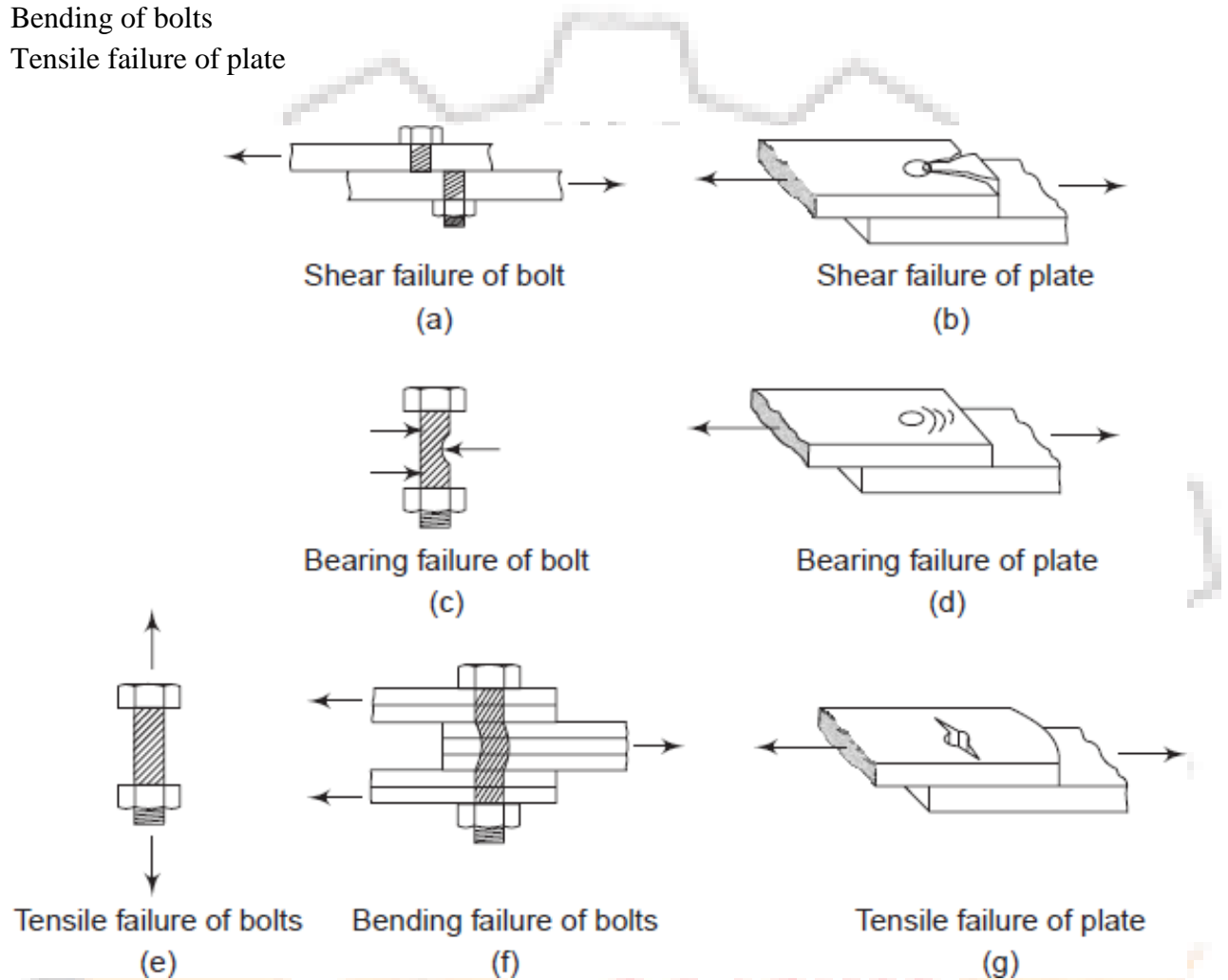

Figure 10.12 Possible failure modes of bolted connections

The force transmission through the bolts are shown in Figure 10.13. Figures 10.14, 10.15 and 10.16 show the failure of bolt in bearing, the failure of bolt in tearing and the failure of plate in bearing respectively.

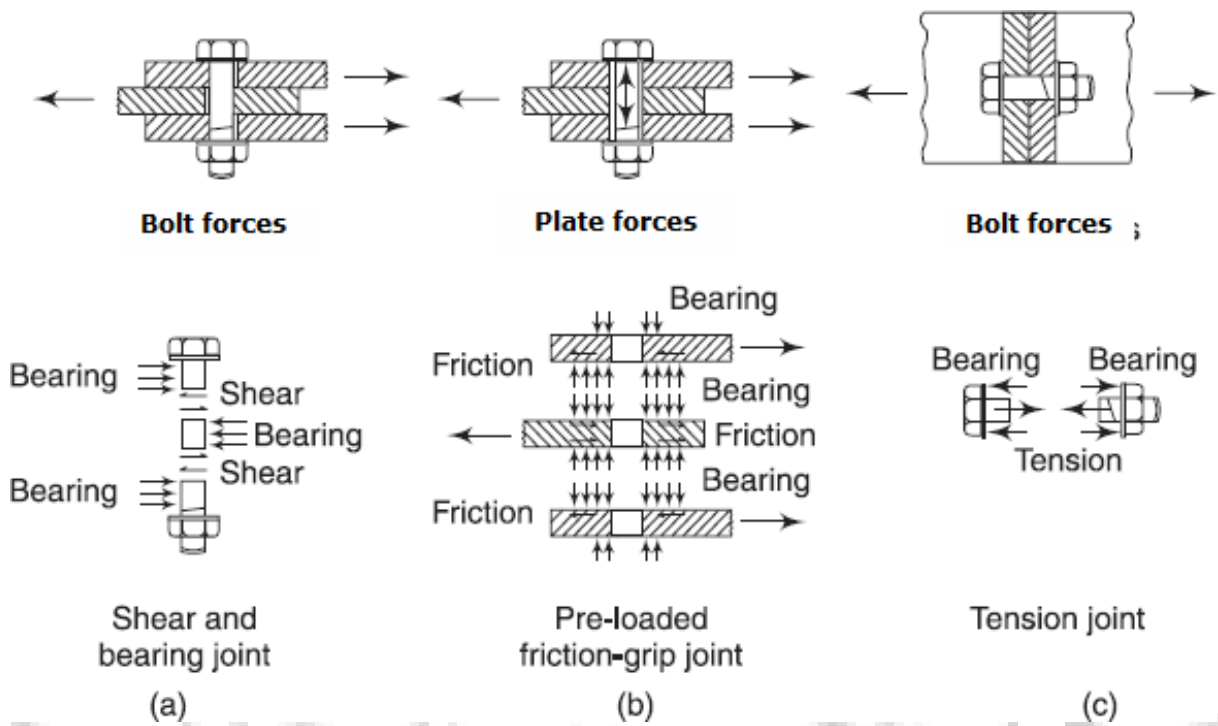

Figure 10.13 Force transmission through bolts

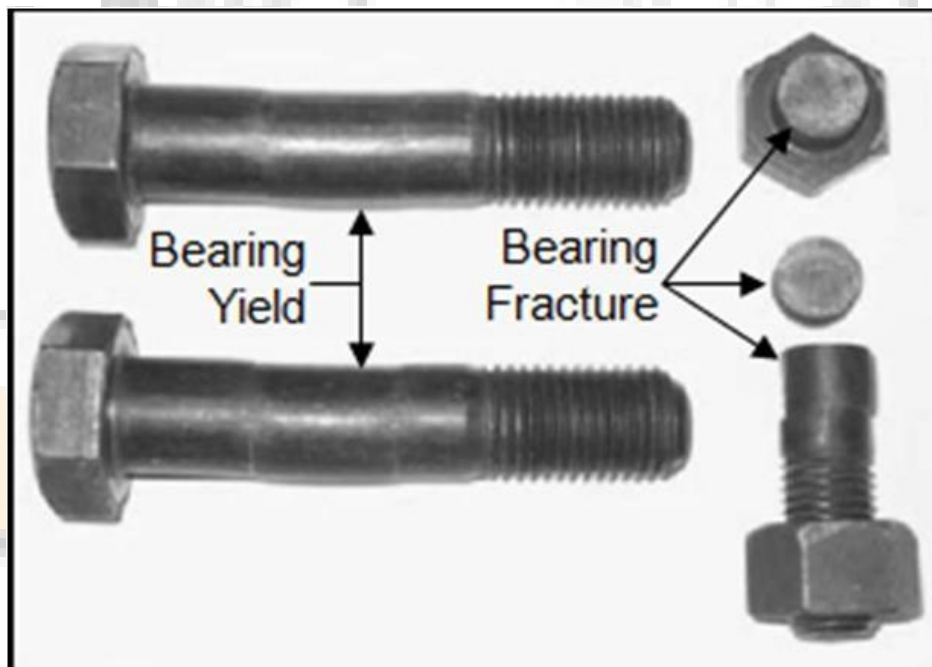

Figure 10.14 Bearing failure of bolts

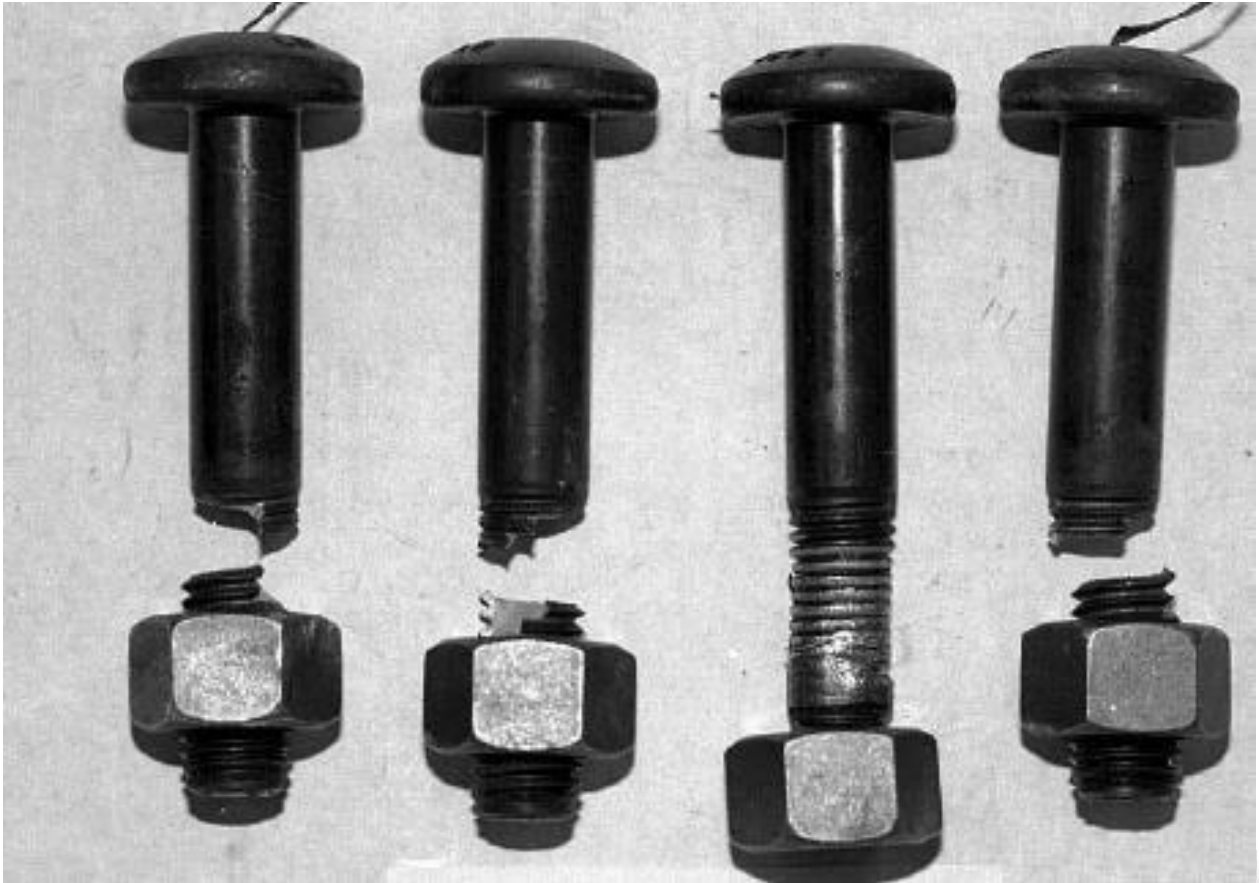

Figure 10.15 tension failure of the bolts



Figure 10.16 Bearing failure of plates

Design Strength of Ordinary Black Bolts

The nominal capacity, V_{nsb} , of a bolt in shear is given in the code as

$$V_{nsb} = (f_u / \sqrt{3})(n_n A_{nb} + n_s A_{sb}) \beta_{lj} \beta_{lg} \beta_{pk}$$

where n_n = number of shear planes with threads intercepting the shear plane,

n_s = number of shear planes without threads intercepting the shear plane,

β_{lj} = reduction factor which allows for the overloading of end bolts that occur in long connections

β_{lg} = reduction factor that allows for the effect of large grip length,

β_{pk} = reduction factor to account for packing plates in excess of 6mm.

The factored shear force V_{sb} should satisfy $V_{sb} \leq V_{nsb} / \gamma_{mb}$ ($\gamma_{mb} = 1.25$)

Design Strength of Black Bolts (cont.)

A_{sb} = Nominal shank area

A_{nb} = Net tensile stress area through the threads

$$A_{nb} = \pi / 4 (d - 0.9382p)^2 \approx 0.78 A_{sb}$$

p = pitch of thread, mm

Reduction Factor for Long Joints:

$$\beta_{lj} = 1.075 - l_j / (200 d) \text{ with } 0.75 \leq \beta_{lj} \leq 1.0$$

Reduction Factor for Large Grip Length:

$$\beta_{lg} = 8d / (3d + l_g); l_g \leq 8d; \beta_{lg} \leq \beta_{lj}$$

Reduction Factor for Packing plate:

$$\beta_{pk} = (1 - 0.0125 t_{pk}); t_{pk} \text{ is the thickness of the thicker packing plate in mm}$$

Bolts in Tension

The nominal capacity of a bolt in tension is:

$$T_{nb} = 0.90 f_{ub} A_{nb} < f_{yb} A_{sb} (\gamma_{m1} / \gamma_{m0})$$

where A_{sb} = Shank area of bolt

A_{nb} = Net Tensile Stress area of bolt

f_{yb} = Yield stress of the bolt

$$\gamma_{m1} = 1.25; \gamma_{m0} = 1.10$$

The factored tension force T_b shall satisfy

$$T_b \leq T_{nb} / \gamma_{mb}; \gamma_{mb} = 1.25$$

If any of the connecting plates is flexible, the additional prying forces must be considered

Bolts in Bearing

Bolts in Bearing

The nominal bearing strength of the bolt is :

$$V_{npb} = 2.5 k_b d t f_u$$

f_u = Ultimate tensile stress of the plate in MPa

d = nominal diameter of the bolt in mm

t = summation of the thicknesses of the connected plates experiencing bearing stress in the same direction (If the bolts are countersunk, the thickness of the plate minus one half of the depth of counter sinking)

k_b is smaller of $e/(3d_o)$, $p/(3d_o)-0.25$, f_{ub}/f_u and 1.0,

where f_{ub} is the ultimate tensile stress of the bolt, e is the edge distance, p is the pitch of the fastener along bearing direction, and d_o is the diameter of the bolt hole.

V_{npb} should be multiplied by a factor 0.7 for over size or short slotted holes and by 0.5 for long slotted holes.

The factor k_b takes into account inadequate edge distance or pitch and also prevents bearing failure of bolts.

If we adopt a minimum edge distance of 1.5 x bolt hole diameter and a minimum pitch of 2.5 x diameter of bolt, k_b may be approximately taken as 0.50.

The bolt bearing on any plate subjected to a factored shear force V_{sb} , shall satisfy

$$V_{sb} \leq V_{npb} / \gamma_{mb} \quad ; \quad \gamma_{mb} = 1.25$$

Tables 10.6, 10.7 and 10.8 will aid the designer while designing joints using ordinary bolts.

Table 10.6 Strength of Bolts in Clearance Holes

	Bolt grade 4.6 N/mm ²	Bolt grade 8.8 N/mm ²	Other grades of Bolts N/mm ²
Shear strength, V_{nsb}	185	370	$f_u / (\sqrt{3} \times 1.25)$
Bearing strength, V_{npb}	400	800	$2.5 k_b f_u / 1.25 (k_b = 0.5)$
Tension strength, t_{nb}	272	576	$0.9 f_{bu} / (1.25)$ not greater than $f_{yb} / (1.25/1.1)$

Table 10.7 Bearing strength v_{npp} of connected parts for ordinary bolts in clearance holes in N/mm²

Grade 410	Grade 540	Grade 570	Other grades
820	540	570	$2.5 k_b f_u / 1.25$

Table 10.8 Design capacity of ordinary bolts based on net tensile area (grade 4.6)

Bolt size, $d(\text{mm})$	Thread stress area (mm^2)	Tension capacity, $T_b(\text{kN})$ $t_{nb} = 272$ MPa	Single shear capacity, $V_{sb}(\text{kN})$ $v_{nsb} = 185$ MPa	Minimum thickness of ply for bolt bearing $v_{npb} = 400$ MPa $t_{bb} = t_e$, mm
(12)	84.3	23.9	15.6	3.2
16	157	42.7	29.0	4.5
20	245	66.6	45.3	5.6
(22)	303	82.9	56.0	6.3
24	353	96.0	65.3	6.8
(27)	459	124.8	84.9	7.8
30	561	152.5	103.8	8.6
36	817	222.2	151.1	10.5

$V_{sb} = A_{nb}v_{nsb}$; $T_b = A_{nb}t_{nb}$; $t_{bb} = V_{npb}/(dv_{npb})$; Sizes in brackets are not preferred

10.2 Design of a tension Member

The following example is given to explain the application of tension member design provisions of the code.

A tie member in a bracing system consists of two angles $75 \times 75 \times 6$ bolted to 10 mm gusset, one on each side using single row of bolts (Fig. 10.17a) and tack bolted. Determine the tensile capacity of the member and the number of bolts required to develop full capacity of the member. What will be the capacity if the angles are connected on the same side of the gusset plate and tack bolted (Fig. 10.17 b)? What is the effect on tensile strength if the members are not tack bolted?

Solution

a).. Two angles connected to opposite side of the gusset as in Fig. 10.17a

(i) Design strength due to yielding of gross section

$$T_{dg} = f_y(A_g/\gamma_{m0})$$

$$A_g = 866 \text{ mm}^2 \text{ (for a single angle)}$$

$$T_{dg} = 250 \times 2 \times (866/1.10) \times 10^{-3}$$

$$T_{dg} = 393.64 \text{ kN}$$

(ii) The design strength governed by tearing at net section

$$T_{dn} = \alpha A_n(f_u/\gamma_{m1})$$

Assume single line of four numbers of 20mm diameter

bolts ($\alpha=0.8$)

$$A_n = [(75 - 6/2 - 22) 6 + (75 - 6/2) 6] 2$$

$$A_n = (300 + 432) 2 = 1464 \text{ mm}^2$$

$$T_{dn} = (0.8 \times 1464 \times 410 / 1.25) / 1000 = 384.15 \text{ kN}$$

Therefore Tensile capacity = 384.15 kN

Design of bolts:

Choose edge distance = 35 mm

Capacity of bolt in double shear (Table 10.8)

$$= 2 \times 45.3 = 90.6 \text{ kN}$$

Bearing capacity of the bolt does not govern as per Table 10.7

Hence strength of a single bolt = 90.6 kN

Provide 5 bolts

$$\text{Total strength of the bolt} = 5 \times 90.6 = 453 \text{ kN} > 384.15 \text{ kN}$$

Hence safe.

$$\text{Minimum spacing} = 2.5 t = 2.5 \times 20 = 50 \text{ mm}$$

Provide a spacing of 50 mm

The arrangements of bolts are shown in Fig. 10.17c

Check for block shear strength: (clause 6.4)

Block shear strength T_{db} of connection shall be taken as the smaller of,

$$T_{db1} = [A_{vg} f_y / (\sqrt{3} m_0) + 0.9 A_{tn} f_u / \lambda m_1]$$

$$T_{db2} = [0.9 f_u A_{vn} / (\sqrt{3} \gamma m_1) + f_y A_{tg} / \gamma m_0]$$

$$A_{vg} = (4 \times 50 + 35) 6 = 1410 \text{ mm}^2$$

$$A_{vn} = (4 \times 50 + 35 - 4.5 \times 22) 6 = 816 \text{ mm}^2$$

$$A_{tn} = (35.0 - 22/2) 6 = 144 \text{ mm}^2$$

$$A_{tg} = (35 \times 6) = 210 \text{ mm}^2$$

$$T_{db1} = [1410 \times 250 / (\sqrt{3} \times 1.10) + 0.9 \times 144 \times 410 / 1.25] \times 10^{-3} = 227.5 \text{ kN}$$

$$T_{db2} = [0.9 \times 410 \times 816 / (\sqrt{3} \times 1.25)] + 250 \times 210 / 1.10 \times 10^{-3} = 186.8 \text{ kN}$$

For double angle block shear strength = $2 \times 186.8 = 373.6 \text{ kN}$

Therefore Tensile capacity = 373.6 kN (smallest of 393.64 kN, 384.15 kN and 373.6 kN)

b) Two angles connected to the same side of the gusset plate (Fig. 10.17b)

i. Design strength due to yielding of Gross section = 393.64 kN

ii. Design strength governed by tearing at net section = 384.15 kN

Assuming 10 bolts of 20 mm diameter, five bolts in each connected leg

Capacity of M20 bolt in single shear = 45.3 kN

$$\text{Total strength of bolts} = 10 \times 45.3 = 453 \text{ kN} > 393.64 \text{ kN}$$

Hence the connection is safe.

The arrangement of bolts is shown in Fig. 10.12d. Since it is similar to the arrangement in Fig. 10.17c, the block shear strength will be same, i.e. 373.6 kN.

Hence the tensile capacity = 373.6 kN

The tensile capacities of both the arrangements (angles connected on the same side and connected to the opposite side of gusset) are same as per the code though the load application is eccentric in this case. Moreover, the number of bolts is 10 whereas in case (a) we used only 5 bolts since the bolts were in double shear.

c) If the angles are not tack bolted, they behave as single angles connected to gusset plate.

In this case also the tensile capacity will be the same and we have to use 10 numbers of M20 bolts. This fact is confirmed by the test and FEM results, which states that "the net section strength of double angles on opposite sides of the gusset and tack connected adequately over the length is nearly the same as that of two single angles acting individually. Current design provisions indicating greater efficiency of such double angles are not supported by test and FEM results".

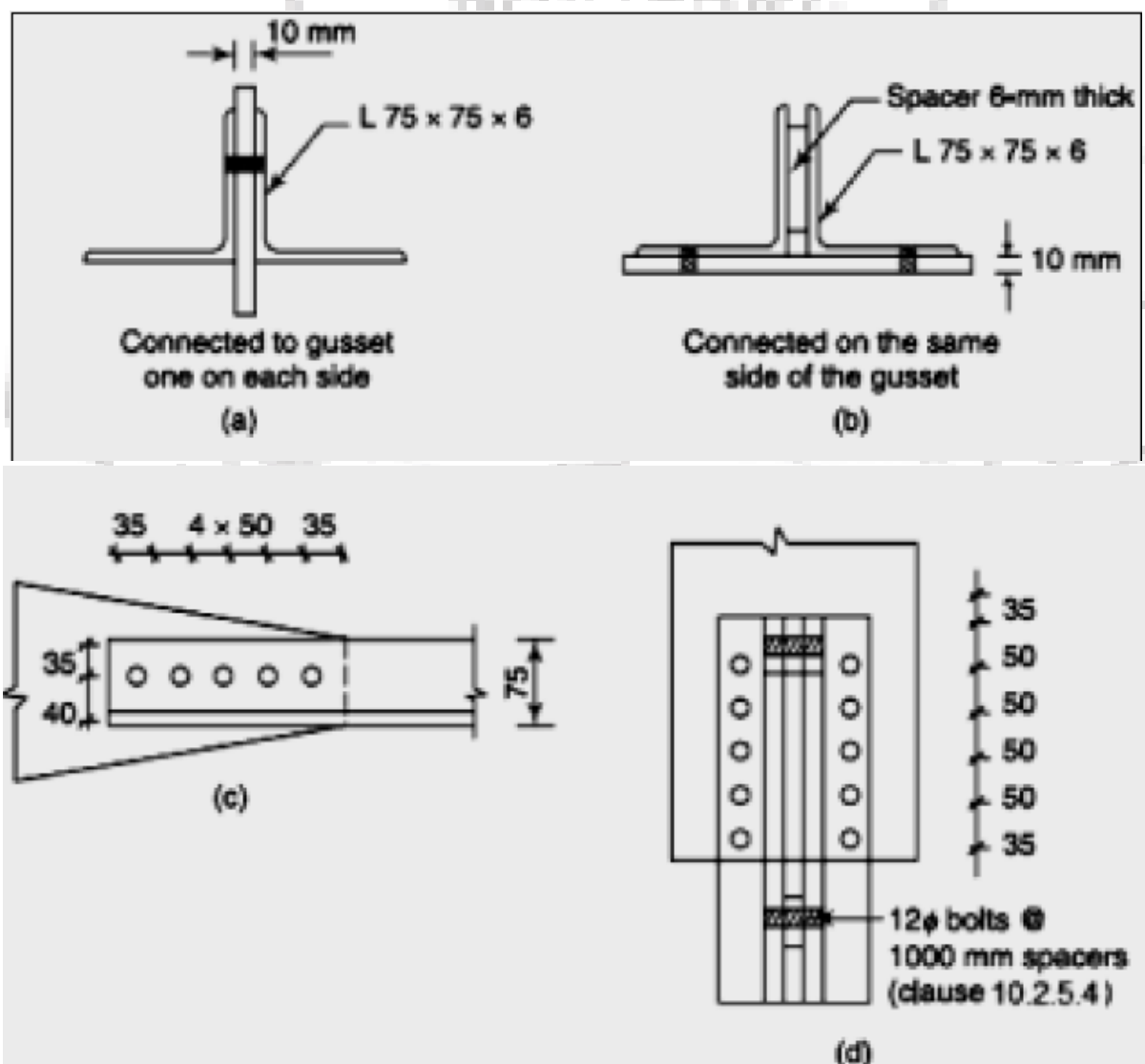

Figure 10.17 Example problem

Sample Questions in Steel Structures

Q1. A builtup steel beam comprises of two flange plates 250 mm wide x 10 mm thick and web plate 330 mm deep x 6 mm thick. The moment of inertia of the section is $162.5 \times 10^6 \text{ mm}^4$. The allowable normal stress in the extreme fibres of flange plates is 140 N/mm^2 . And the average allowable shear stress in the web plate is 100 N/mm^2 . Compute the flexural and shear capacities of beam. The flange plates are welded to web plate by 6 mm intermittent fillet welds. The allowable shear stress in weld material is 100 N/mm^2 . Determine the percentage of weld length for intermittent welding at the section of maximum shear. At a section of maximum bending moment, the flange plates are to be spliced using 12 mm thick plates. The maximum allowable normal stress in splice plate is 150 N/mm^2 . Determine the minimum width B of flange splice plate. The total length of flange splice plate is L and it is welded all around using 6 mm fillet weld. Determine length L.

Q2. a) Details of a double angle web member of a steel roof truss are given below. Check to see if the member has the capacity to carry tensile force of 240 KN and compressive force of 165 KN at service load. The member consists of 2-ISA 90x90x6 connected to opposite sides of 8 mm gussets using 20 mm bolts.

Effective length for buckling about xx axis = 1.7 m

Effective length for buckling about yy axis = 4.0 m

Yield strength of steel used = 250 MPa

Properties of single ISA 90x90x6 are

Area = 1047 mm^2 , $\bar{y} = 24.2 \text{ mm}$, $I_{xx} = 801000 \text{ mm}^4$

$$\text{Allowable compressive stress} = \frac{0.60 f_y f_{cc}}{(f_y^{1.5} + f_{cc}^{1.5})^{1/1.5}}$$

Where f_{cc} = Euler buckling stress

b) Calculate the number of bolts required at the end connections of the angle to the gussets using 20 mm bolts given the allowable shear stress in the bolt = 80 MPa and allowable bearing stress = 250 MPa

Q3. Two plates are proposed to be jointed by welding. Determine the size and length of the weld required to develop the full strength of the smallest plate which is 8 cm x 1.2 cm. Assume permissible tension in plate is 1500 Kg/cm^2 and permissible shear in fillet weld is 1025 Kg/cm .

Q4. Design a compression member when effective length is 1.5 m and which carries a load of 12000 Kg. Use angle sections and data given below

Angle	Sectional area cm^2	Radius of gyration (cm)	of r_{\min}	l/r	Allowable stress in axial compression kg/cm^2
ISA 65x65x10	12.0	1.25		70	1075

ISA 70x70x10	13.02	1.35	80	1007
ISA 75x75x10	14.02	1.45	90	928
ISA 80x80x10	17.81	1.64	100	840
ISA 90x90x10	20.12	1.64	110	753

Q5. Check the adequacy of the rafter member of a roof truss made of 2-ISA 90x90x6 double angles back to back made of mild steel for tension and compression given below. The length of the rafter member between nodes of the truss is 1.5 m. The effective length factor for buckling of the member in the plane of the truss is 0.85 and that for out of plane of the truss is 1.0. The member is connected to the end gussets 6 mm thick using 20 mm diameter bolts
Area of ISA 90x90x6 = 1047mm^2 , $I_{xx} = 801000\text{mm}^4$, distance of centre of gravity from the back = 24.2mm , The compression in the member due to dead + live loads = 300 KN
The tension in the member due to dead load + wind uplift = 250 KN
The allowable stress in compression are as follows:

(kl/r)	30	40	50	60
σ_{ac} in MPa	145	145	139	122

